



RX-V540/RX-V440

AV Receiver

OWNER'S MANUAL

IMPORTANT SAFETY INSTRUCTIONS

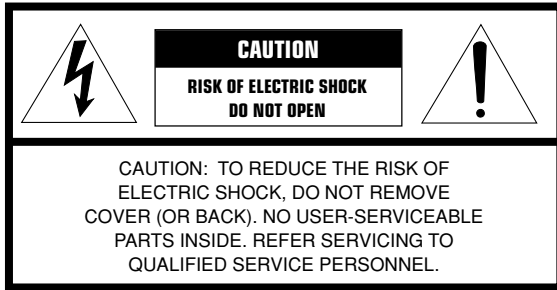

• Explanation of Graphical Symbols

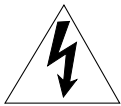

The lightning flash with arrowhead symbol, within an equilateral triangle, is intended to alert you to the presence of uninsulated "dangerous voltage" within the product's enclosure that may be of sufficient magnitude to constitute a risk of electric shock to persons.



The exclamation point within an equilateral triangle is intended to alert you to the presence of important operating and maintenance (servicing) instructions in the literature accompanying the appliance.

- 1 Read Instructions – All the safety and operating instructions should be read before the product is operated.
- 2 Retain Instructions – The safety and operating instructions should be retained for future reference.
- 3 Heed Warnings – All warnings on the product and in the operating instructions should be adhered to.
- 4 Follow Instructions – All operating and use instructions should be followed.
- 5 Cleaning – Unplug this product from the wall outlet before cleaning. Do not use liquid cleaners or aerosol cleaners. Use a damp cloth for cleaning.
- 6 Attachments – Do not use attachments not recommended by the product manufacturer as they may cause hazards.
- 7 Water and Moisture – Do not use this product near water – for example, near a bath tub, wash bowl, kitchen sink, or laundry tub; in a wet basement; or near a swimming pool; and the like.
- 8 Accessories – Do not place this product on an unstable cart, stand, tripod, bracket, or table. The product may fall, causing serious injury to a child or adult, and serious damage to the product. Use only with a cart, stand, tripod, bracket, or table recommended by the manufacturer, or sold with the product. Any mounting of the product should follow the manufacturer's instructions, and should use a mounting accessory recommended by the manufacturer.
- 9 A product and cart combination should be moved with care. Quick stops, excessive force, and uneven surfaces may cause the product and cart combination to overturn.



- 10 Ventilation – Slots and openings in the cabinet are provided for ventilation and to ensure reliable operation of the product and to protect it from overheating, and these openings must not be blocked or covered. The openings should never be blocked by placing the product on a bed, sofa, rug, or other similar surface. This product should not be placed in a built-in installation such as a bookcase or rack unless proper ventilation is provided or the manufacturer's instructions have been adhered to.
- 11 Power Sources – This product should be operated only from the type of power source indicated on the marking label. If you are not sure of the type of power supply to your home, consult your product dealer or local power company. For products intended to operate from battery power, or other sources, refer to the operating instructions.
- 12 Grounding or Polarization – This product may be equipped with a polarized alternating current line plug (a plug having one blade wider than the other). This plug will fit into the power outlet only one way. This is a safety feature. If you are unable to insert the plug fully into the outlet, try reversing the plug. If the plug should still fail to fit, contact your electrician to replace your obsolete outlet. Do not defeat the safety purpose of the polarized plug.
- 13 Power-Cord Protection – Power-supply cords should be routed so that they are not likely to be walked on or pinched by items placed upon or against them, paying particular attention to cords at plugs, convenience receptacles, and the point where they exit from the product.
- 14 Lightning – For added protection for this product during a lightning storm, or when it is left unattended and unused for long periods of time, unplug it from the wall outlet and disconnect the antenna or cable system. This will prevent damage to the product due to lightning and power-line surges.
- 15 Power Lines – An outside antenna system should not be located in the vicinity of overhead power lines or other electric light or power circuits, or where it can fall into such power lines or circuits. When installing an outside antenna system, extreme care should be taken to keep from touching such power lines or circuits as contact with them might be fatal.
- 16 Overloading – Do not overload wall outlets, extension cords, or integral convenience receptacles as this can result in a risk of fire or electric shock.
- 17 Object and Liquid Entry – Never push objects of any kind into this product through openings as they may touch dangerous voltage points or short-out parts that could result in a fire or electric shock. Never spill liquid of any kind on the product.
- 18 Servicing – Do not attempt to service this product yourself as opening or removing covers may expose you to dangerous voltage or other hazards. Refer all servicing to qualified service personnel.
- 19 Damage Requiring Service – Unplug this product from the wall outlet and refer servicing to qualified service personnel under the following conditions:
 - a) When the power-supply cord or plug is damaged,
 - b) If liquid has been spilled, or objects have fallen into the product,
 - c) If the product has been exposed to rain or water,

- d) If the product does not operate normally by following the operating instructions. Adjust only those controls that are covered by the operating instructions as an improper adjustment of other controls may result in damage and will often require extensive work by a qualified technician to restore the product to its normal operation,
 - e) If the product has been dropped or damaged in any way, and
 - f) When the product exhibits a distinct change in performance - this indicates a need for service.
- 20 Replacement Parts – When replacement parts are required, be sure the service technician has used replacement parts specified by the manufacturer or have the same characteristics as the original part. Unauthorized substitutions may result in fire, electric shock, or other hazards.
- 21 Safety Check – Upon completion of any service or repairs to this product, ask the service technician to perform safety checks to determine that the product is in proper operating condition.
- 22 Wall or Ceiling Mounting – The unit should be mounted to a wall or ceiling only as recommended by the manufacturer.
- 23 Heat – The product should be situated away from heat sources such as radiators, heat registers, stoves, or other products (including amplifiers) that produce heat.

- 24 Outdoor Antenna Grounding – If an outside antenna or cable system is connected to the product, be sure the antenna or cable system is grounded so as to provide some protection against voltage surges and built-up static charges. Article 810 of the National Electrical Code, ANSI/NFPA 70, provides information with regard to proper grounding of the mast and supporting structure, grounding of the lead-in wire to an antenna discharge unit, size of grounding conductors, location of antenna discharge unit, connection to grounding electrodes, and requirements for the grounding electrode.

EXAMPLE OF ANTENNA GROUNDING

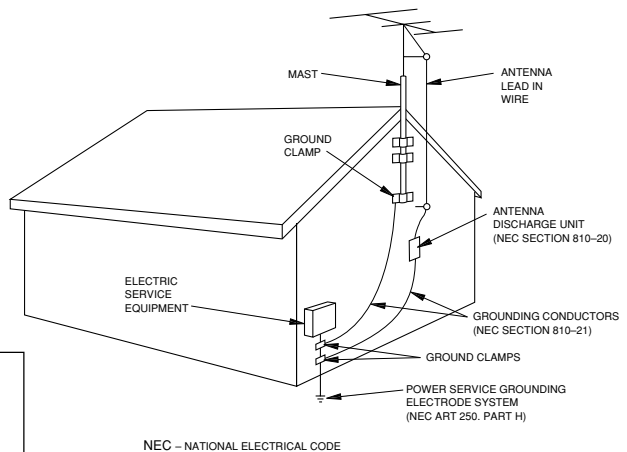

Note to CATV system installer:

This reminder is provided to call the CATV system installer's attention to Article 820-40 of the NEC that provides guidelines for proper grounding and, in particular, specifies that the cable ground shall be connected to the grounding system of the building, as close to the point of cable entry as practical.

FCC INFORMATION (for US customers)

1. **IMPORTANT NOTICE : DO NOT MODIFY THIS UNIT!**
This product, when installed as indicated in the instructions contained in this manual, meets FCC requirements. Modifications not expressly approved by Yamaha may void your authority, granted by the FCC, to use the product.
2. **IMPORTANT :** When connecting this product to accessories and/or another product use only high quality shielded cables. Cable/s supplied with this product **MUST** be used. Follow all installation instructions. Failure to follow instructions could void your FCC authorization to use this product in the USA.
3. **NOTE :** This product has been tested and found to comply with the requirements listed in FCC Regulations, Part 15 for Class "B" digital devices. Compliance with these requirements provides a reasonable level of assurance that your use of this product in a residential environment will not result in harmful interference with other electronic devices. This equipment generates/uses radio frequencies and, if not installed and used according to the instructions found in the users manual, may cause interference harmful to the operation of other electronic devices.

Compliance with FCC regulations does not guarantee that interference will not occur in all installations. If this product is found to be the source of interference, which can be determined by turning the unit "OFF" and "ON", please try to eliminate the problem by using one of the following measures:

- Relocate either this product or the device that is being affected by the interference.
- Utilize power outlets that are on different branch (circuit breaker or fuse) circuits or install AC line filter/s.
- In the case of radio or TV interference, relocate/reorient the antenna. If the antenna lead-in is 300 ohm ribbon lead, change the lead-in to coaxial type cable.
- If these corrective measures do not produce satisfactory results, please contact the local retailer authorized to distribute this type of product. If you can not locate the appropriate retailer, please contact Yamaha Electronics Corp., U.S.A. 6660 Orangethorpe Ave, Buena Park, CA 90620.
- The above statements apply **ONLY** to those products distributed by Yamaha Corporation of America or its subsidiaries.

CAUTION: READ THIS BEFORE OPERATING YOUR UNIT.

- 1 To assure the finest performance, please read this manual carefully. Keep it in a safe place for future reference.
- 2 Install this sound system in a well ventilated, cool, dry, clean place — away from direct sunlight, heat sources, vibration, dust, moisture, and/or cold. Allow ventilation space of at least 30 cm on the top, 20 cm on the left and right, and 20 cm on the back of this unit.
- 3 Locate this unit away from other electrical appliances, motors, or transformers to avoid humming sounds.
- 4 Do not expose this unit to sudden temperature changes from cold to hot, and do not locate this unit in a environment with high humidity (i.e. a room with a humidifier) to prevent condensation inside this unit, which may cause an electrical shock, fire, damage to this unit, and/or personal injury.
- 5 Avoid installing this unit where foreign object may fall onto this unit and/or this unit may be exposed to liquid dripping or splashing. On the top of this unit, do not place:
 - Other components, as they may cause damage and/or discoloration on the surface of this unit.
 - Burning objects (i.e. candles), as they may cause fire, damage to this unit, and/or personal injury.
 - Containers with liquid in them, as they may fall and liquid may cause electrical shock to the user and/or damage to this unit.
- 6 Do not cover this unit with a newspaper, tablecloth, curtain, etc. in order not to obstruct heat radiation. If the temperature inside this unit rises, it may cause fire, damage to this unit, and/or personal injury.
- 7 Do not plug in this unit to a wall outlet until all connections are complete.
- 8 Do not operate this unit upside-down. It may overheat, possibly causing damage.
- 9 Do not use force on switches, knobs and/or cords.
- 10 When disconnecting the power cord from the wall outlet, grasp the plug; do not pull the cord.
- 11 Do not clean this unit with chemical solvents; this might damage the finish. Use a clean, dry cloth.
- 12 Only voltage specified on this unit must be used. Using this unit with a higher voltage than specified is dangerous and may cause fire, damage to this unit, and/or personal injury. YAMAHA will not be held responsible for any damage resulting from use of this unit with a voltage other than specified.
- 13 To prevent damage by lightning, disconnect the power cord from the wall outlet during an electrical storm.
- 14 Do not attempt to modify or fix this unit. Contact qualified YAMAHA service personnel when any service is needed. The cabinet should never be opened for any reasons.
- 15 When not planning to use this unit for long periods of time (i.e. vacation), disconnect the AC power plug from the wall outlet.
- 16 Be sure to read the “TROUBLESHOOTING” section on common operating errors before concluding that this unit is faulty.
- 17 Before moving this unit, press STANDBY/ON to set this unit in standby mode, and disconnect the AC power plug from the wall outlet.
- 18 **VOLTAGE SELECTOR (China and General models only)**
The VOLTAGE SELECTOR on the rear panel of this unit must be set for your local main voltage BEFORE plugging into the AC main supply. Voltages are 110/120/220/240 V AC, 50/60 Hz.

This unit is not disconnected from the AC power source as long as it is connected to the wall outlet, even if this unit itself is turned off. This state is called standby mode. In this state, this unit is designed to consume a very small quantity of power.

WARNING

TO REDUCE THE RISK OF FIRE OR ELECTRIC SHOCK, DO NOT EXPOSE THIS UNIT TO RAIN OR MOISTURE.

IMPORTANT

Please record the serial number of this unit in the space below.

MODEL:

Serial No.:

The serial number is located on the rear of the unit.

Retain this Owner's Manual in a safe place for future reference.

FOR CANADIAN CUSTOMERS

To prevent electric shock, match wide blade of plug to wide slot and fully insert.

This Class B digital apparatus complies with Canadian ICES-003.

We Want You Listening For A Lifetime

YAMAHA and the Electronic Industries Association's Consumer Electronics Group want you to get the most out of your equipment by playing it at a safe level. One that lets the sound come through loud and clear without annoying blaring or distortion – and, most importantly, without affecting your sensitive hearing.

Since hearing damage from loud sounds is often undetectable until it is too late, YAMAHA and the Electronic Industries Association's Consumer Electronics Group recommend you to avoid prolonged exposure from excessive volume levels.



CONTENTS

INTRODUCTION

CONTENTS	1
FEATURES	2
GETTING STARTED	3
Supplied accessories	3
Installing batteries in the remote control	3
CONTROLS AND FUNCTIONS	4
Front panel	4
Remote control	6
Front panel display	8

PREPARATION

CONNECTIONS	9
Before connecting components	9
Connecting video components	10
Connecting audio components	12
Connecting the antennas	13
Connecting an external decoder	14
Connecting the speakers	15
Connecting the power supply cords	18
Turning on the power	18
BASIC SYSTEM SETTINGS	19
Using the basic menu	19
Setting the unit to match your speaker system	21
Setting speaker output levels (SP LEVEL)	21

BASIC OPERATION

PLAYBACK	22
Input modes and indications	24
Selecting a sound field program	25
DIGITAL SOUND FIELD PROCESSING (DSP)	28
Understanding sound fields	28
Hi-Fi DSP programs	28
CINEMA-DSP	29
Sound design of CINEMA-DSP	29
CINEMA-DSP Programs	29
Sound field effects	31
TUNING	32
Presetting stations	33
Selecting a preset station	35
SLEEP TIMER	36
RECORDING	37

ADVANCED OPERATION

SET MENU	38
Set menu list	38
Adjusting the items on the set menu	38
SOUND 1 SPEAKER SET (speaker mode settings)	39
SOUND 2 SP DISTANCE (speaker distance)	41
SOUND 3 LFE LEVEL	41
SOUND 4 D. RANGE (dynamic range)	41
SOUND 5 CENTER GEQ	42
(center graphic equalizer)	42
SOUND 6 HP TONE CTRL	42
(headphone tone control)	42
INPUT 1 I/O ASSIGN (input/output assignment) ..	42
INPUT 2 INPUT MODE (initial input mode)	43
OPTION 1 DISPLAY SET	43
OPTION 2 MEM. GUARD (memory guard)	43
OPTION 3 AUDIO MUTE	43
OPTION 4 ZONE SET	44
REMOTE CONTROL FEATURES	45
Control area	45
Setting the manufacturer code	46
Clearing setup manufacturer codes	46
Controlling other components	47
SETTING THE SPEAKER LEVELS	48
Adjusting the volume during playback	48
Using the test tone	48

ADDITIONAL INFORMATION

SOUND FIELD PROGRAM PARAMETER	
EDITING	49
Changing parameter settings	49
Digital sound field parameter descriptions	50
TROUBLESHOOTING	51
GLOSSARY	55
SPECIFICATIONS	57

FEATURES

Built-in 6-channel power amplifier

- ◆ Minimum RMS output power (0.06% THD, 20 Hz – 20 kHz, 8Ω)

RX-V540

[U.S.A. and Canada models]

Main: 80 W + 80 W

Center: 80 W

Rear: 80 W + 80 W

Rear center: 80 W

[Other models]

Main: 70 W + 70 W

Center: 70 W

Rear: 70 W + 70 W

Rear center: 70 W

RX-V440

[U.S.A. and Canada models]

Main: 75 W + 75 W

Center: 75 W

Rear: 75 W + 75 W

Rear center: 75 W

[Other models]

Main: 65 W + 65 W

Center: 65 W

Rear: 65 W + 65 W

Rear center: 65 W

Multi-mode digital sound field processing

- ◆ Dolby Pro Logic/Dolby Pro Logic II decoder
- ◆ Dolby Digital/Dolby Digital EX decoder
- ◆ DTS/DTS-ES Matrix 6.1, Discrete 6.1, DTS Neo:6 Decoder
- ◆ CINEMA DSP: Combination of YAMAHA DSP technology and Dolby Pro Logic, Dolby Digital or DTS
- ◆ Virtual CINEMA DSP
- ◆ SILENT CINEMA DSP

Sophisticated AM/FM Tuner

- ◆ 40-Station random access preset tuning
- ◆ Automatic preset tuning
- ◆ Preset station shifting capability (Preset editing)

Other features

- ◆ 96 kHz/24-bit D/A converter
- ◆ Set menu for optimizing this unit for your Audio/Video system
- ◆ Test tone generator for easier speaker balance adjustment
- ◆ 6-channel external decoder input
- ◆ Component video input/output capability
- ◆ Optical and coaxial digital audio signal jacks
- ◆ Sleep timer
- ◆ Remote control with preset manufacturer codes
- ◆ Zone B capability

RX-V540

- ◆ S-video signal input/output capability
- ◆ Video Conversion (Composite Video ⇔ S Video)

■ About this manual

- This document is the owner's manual for both the RX-V540 and RX-V440. For details on various functions unique to each model, descriptions given for each model name.
-  indicates a tip for your operation.
- Some operations can be performed by using either the buttons on the main unit or on the remote control. In cases when the button names differ between the main unit and the remote control, the button name on the remote control is given in parentheses.
- This manual is printed prior to production. Design and specifications are subject to change in part for the reason of the improvement in operativity ability, and others. In this case, the product has priority.



Manufactured under license from Dolby Laboratories.

“Dolby”, “Pro Logic”, and the double-D symbol are trademarks of Dolby Laboratories.



“DTS”, “DTS-ES Extended Surround” and “Neo:6” are trademarks of Digital Theater System, Inc.

GETTING STARTED

Supplied accessories

After unpacking, check that the following parts are contained.

Remote control

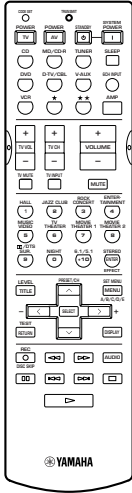

Batteries (4)
(AAA, R03, UM-4)

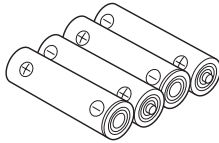

75-ohm/300-ohm antenna
adapter (U.K. model)

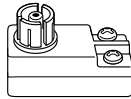

AM loop antenna



Indoor FM antenna
(U.S.A., Canada, China,
Korea and General models)

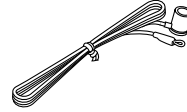

(Europe, U.K., Australia and
Singapore models)

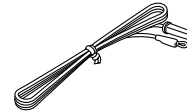

Installing batteries in the remote control

Insert the batteries in the correct direction by aligning the + and – marks on the batteries with the polarity markings (+ and –) inside the battery compartment.

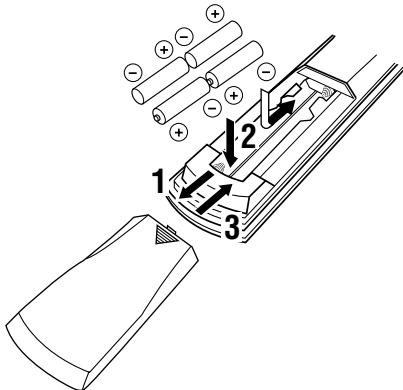

1 Press the part marked with a ▼ and slide off the battery compartment cover.

2 Insert the four batteries supplied (AAA, R03, UM-4) according to the polarity markings on the inside of the battery compartment.

3 Slide the cover back on so that it snaps into place.

Notes on batteries

- Change all of the batteries if you notice a decrease in the operating range of the remote control, that the indicator does not flash, or the light becoming dim.
- Do not use old batteries together with new ones.
- Do not use different types of batteries (such as alkaline and manganese batteries) together. Read the packaging carefully as these different types of batteries may have the same shape and color.
- If the batteries have leaked, dispose of them immediately. Avoid touching the leaked material or letting it come into contact with clothing, etc. Clean the battery compartment thoroughly before installing new batteries.

If the remote control is without batteries for more than 2 minutes, or if exhausted batteries remain in the remote control, the contents of the memory may be cleared. When the memory is cleared, insert new batteries, set up the manufacturer code and program any acquired functions that may have been cleared.

CONTROLS AND FUNCTIONS

Front panel

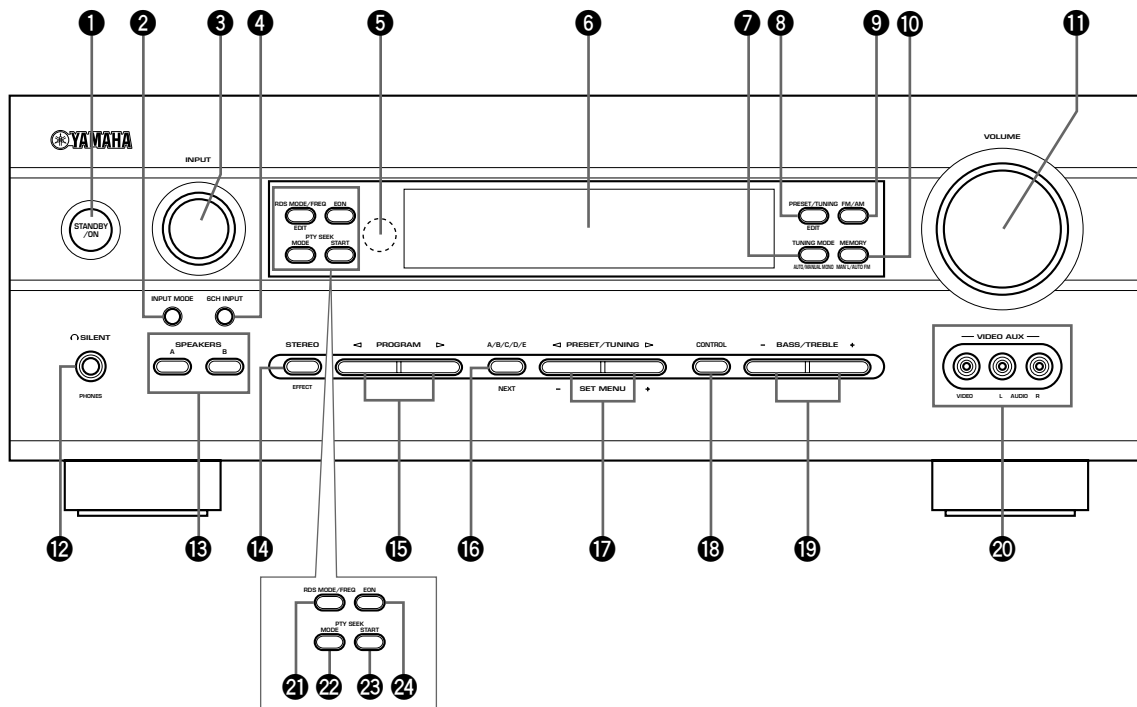

(U.K. and Europe models only)

1 STANDBY/ON

Turns the unit on, or sets it in standby mode. When you turn the unit on, you will hear a click and there will be a 4 to 5-second delay before it can reproduce sound.

Standby mode

In this mode, the unit uses a small amount of power in order to receive infrared-signals from the remote control.

2 INPUT MODE

Sets the priority for the types of input signals (AUTO, DTS, ANALOG) received when one component is connected to two or more input jacks. You cannot set priority for an audio source if you have selected 6CH INPUT as the input source.

3 INPUT

Selects the input source you want to listen to or watch.

4 6CH INPUT

Selects the audio source connected to the 6CH INPUT jacks. This selection takes priority over sources selected with INPUT (or the input selector buttons on the remote control).

5 Remote control sensor

Receives signals from the remote control.

6 Front panel display

Shows information about the operational status of the unit.

7 TUNING MODE (AUTO/MAN'L MONO)

Switches the tuning mode between automatic and manual.

8 PRESET/TUNING (EDIT)

Switches the function of PRESET/TUNING </> between selecting a preset station number and tuning (the colon (:)) turns on or off. This button is also used to exchange the assignment of two preset stations with each other.

9 FM/AM

Switches the reception band between FM and AM.

10 MEMORY (MAN'L/AUTO FM)

Stores the current station in memory.

11 VOLUME

Controls the output level of all audio channels. This does not affect the OUT (REC) level.

12  **SILENT (PHONES jack)**

Allows you to enjoy DSP effects when listening with headphones. When you connect headphones to the headphone jack, no signals are output to the speakers.

13 **SPEAKERS A/B**

Turns the set of main speakers connected to the A and/or B terminals on or off.

14 **STEREO/EFFECT**

Switches between normal stereo and DSP effect reproduction. When you select **STEREO**, the unit mixes down all Dolby Digital and DTS signals (except the LFE channel) as well as those 2-channel signals without effects, to the main left and right speakers.

15 **PROGRAM**  

Select the DSP program.

16 **A/B/C/D/E**

Selects preset station groups A to E when the unit is in tuner mode.

NEXT

Selects the set menu mode when the unit is not in tuner mode.

17 **PRESET/TUNING**  

Select preset station numbers 1 to 8 when a colon (:) is displayed in the front panel display.

Select the tuning frequency when a colon (:) is not displayed when the unit is in tuner mode.

SET MENU  

Adjust settings on the set menu when the unit is not in tuner mode.

18 **CONTROL**

Switches between Bass (low-frequency response) control mode and Treble (high-frequency response) control mode.

19 **BASS/TREBLE**  

Increase or decrease low/high-frequency response when the unit is in Bass/Treble control mode. The sound changes 2dB each time you press one of these buttons. Control range: -10 to +10dB

20 **VIDEO AUX jacks**

Inputs for audio and video signals from a portable external source (game console, etc.). Set the input source to V-AUX to select source signals from these jacks.

(U.K. and Europe models only)**21** **RDS MODE/FREQ**

Press this button when the unit is receiving an RDS station, to cycle the display mode among PS mode, PTY mode, RT mode, CT mode (if the station offers those RDS data service) and/or frequency display mode in turn.

22 **PTY SEEK MODE**

Press this button to set the unit in the PTY SEEK mode.

23 **PTY SEEK START**

Press this button to begin searching for a station after the desired program type has been selected in the PTY SEEK mode.

24 **EON**

Press this button to select a radio program type (NEWS, INFO, AFFAIRS, SPORT) to tune in automatically.

Remote control

This section describes the remote control controls and their functions. Make sure that the AMP mode is selected before starting operation.

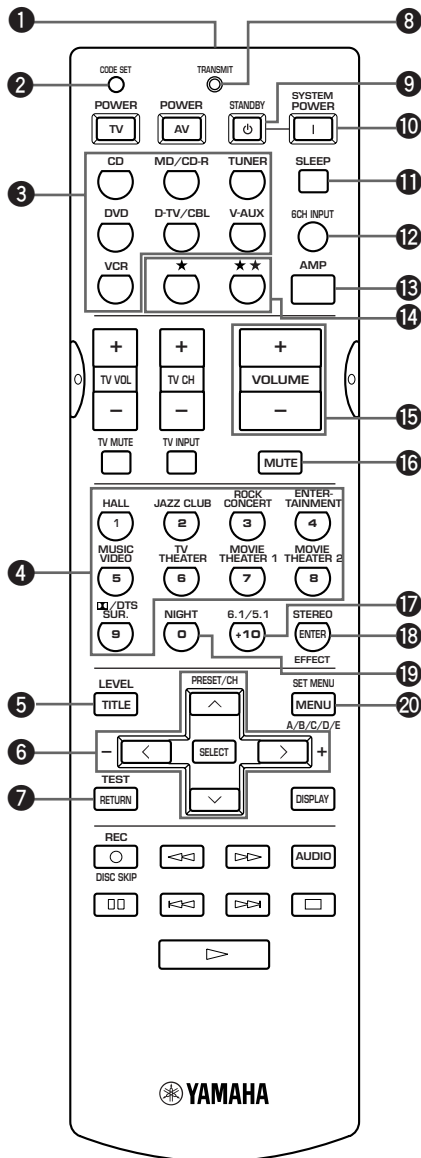

1 Infrared window

Outputs infrared control signals. Aim this window at the component you want to operate.

2 CODE SET

Used to set up manufacturer codes (see page 46).

3 Input selector buttons

Select the input source and set the remote control to operate the selected source component.

4 DSP program

Select DSP programs when the remote control is in AMP mode. Press one of these buttons repeatedly to select a DSP program within a program group.

5 LEVEL

Selects the effect speaker channel to adjust.

6 Multi control section

Used to change and implement settings.

7 TEST

Outputs a test tone for use when adjusting the speaker levels.

8 TRANSMIT indicator

Flashes while the remote control is sending signals.

9 STANDBY

Sets this unit in standby mode.

10 SYSTEM POWER

Turns on the power of the unit.

11 SLEEP

Sets the sleep timer.

12 6CH INPUT

Selects the audio source connected to the 6CH INPUT jacks.

13 AMP

Switches the function of the same controls between AMP and the component selected using the input selector buttons.

14 ★/★★

Sets the remote control to operate other components (not necessarily connected to this unit) without changing this unit's input source.

15 VOLUME +/-

Increases or decreases the volume level.

16 MUTE

Mutes the sound. Press again to restore the audio output to the previous volume level.

17 6.1/5.1

Switches the Dolby Digital EX or DTS ES decoder on or off.

18 STEREO/EFFECT

Switches between normal stereo and DSP effect reproduction. When you select STEREO the unit mixes down all Dolby Digital and DTS signals (except the LFE channel) as well as those 2-channel signals without effect sounds, to the main left and right speakers.

19 NIGHT

Sets the unit in night listening mode.

20 SET MENU

Selects the set menu mode.

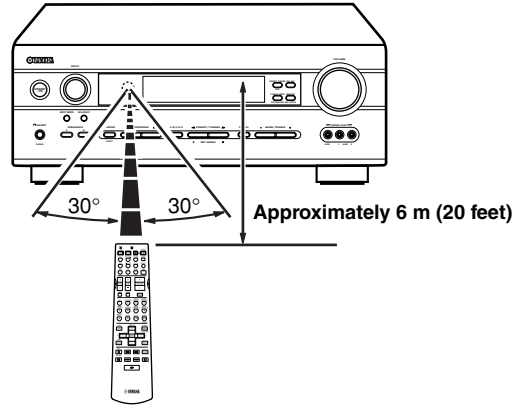
■ Using the remote control

The remote control transmits a directional infrared beam. Be sure to aim the remote control directly at the remote control sensor on the main unit during operation.

■ Handling the remote control

- Do not spill water or other liquids on the remote control.
- Do not drop the remote control.
- Do not leave or store the remote control in the following types of conditions:
 - high humidity or temperature such as near a heater, stove or bath;
 - dusty places; or
 - in places subject to extremely low temperatures.

Front panel display

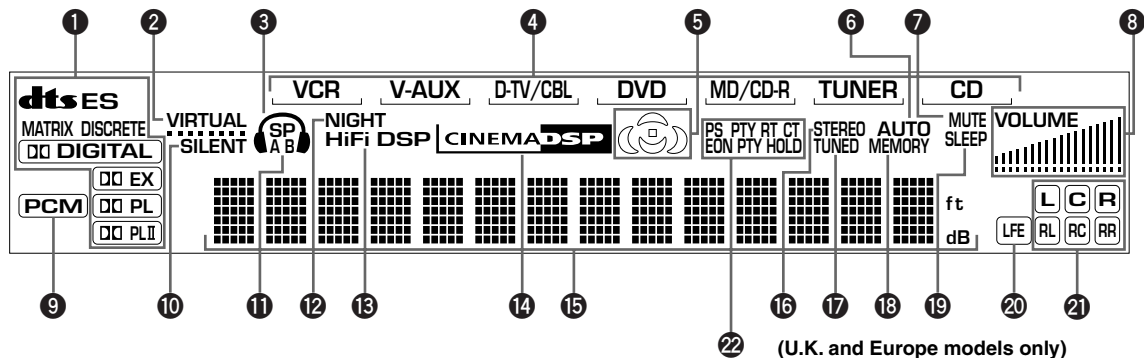

1 Processor indicators

The indicators for the various decoders light up when the decoders are in use.

2 VIRTUAL indicator

Lights up when using Virtual CINEMA DSP.

3 Headphones indicator

Lights up when headphones are connected to the headphone jack.

4 Input source indicator

Highlights the current input source with a cursor.

5 Sound field indicator

Displays the sound field management the unit is using when you listen to a DSP sound field program.

6 AUTO indicator

Shows that this unit is in the automatic tuning mode.

7 MUTE indicator

Flashes while the MUTE function is on.

8 VOLUME level indicator

Indicates the volume level.

9 PCM indicator

Lights up when this unit is reproducing PCM (pulse code modulation) digital audio signals.

10 SILENT indicator

Lights up when headphones are connected and the digital sound field processor is on.

11 SP A B indicator

Lights up to indicate which set of main speakers is selected. Both indicators light up when both sets of speakers are selected.

12 NIGHT indicator

Lights up when the unit is set to night listening mode.

13 HiFi DSP indicator

Lights up when you select a Hi-Fi DSP sound field program.

14 CINEMA DSP indicator

Lights up when you select a CINEMA DSP sound field program.

15 Multi-information display

Shows the current DSP program name and other information when you are adjusting or changing settings.

16 STEREO indicator

Lights up when the unit is receiving a strong signal from a FM stereo broadcast while the "AUTO" indicator is lit.

17 TUNED indicator

Lights up when this unit is tuned to a radio station.

18 MEMORY indicator

Flashes to show a station can be stored in memory.

19 SLEEP indicator

Lights up while the sleep timer is on.

20 LFE indicator

Lights up when the input signal contains an LFE signal.

21 Input channel indicator

The indicators for the appropriate sound channels light up when a digital signal from a source is played back.

22 RDS indicator (U.K. and Europe models only)

The name(s) of the RDS data offered by the currently received RDS station light(s) up.
EON indicator lights up when an RDS station that offers the EON data service is being received.
PTY HOLD indicator lights up while searching for stations in the PTY SEEK mode.

CONNECTIONS

Before connecting components

CAUTION

Do not connect this unit or other components to the mains power until all connections between the components have been completed.

- Be sure all connections are made correctly, that is to say L (left) to L, R (right) to R, “+” to “+” and “-” to “-”. Some components require different connection methods and have different jack names. Refer to the operation instructions for each component you wish to connect to this unit.
- After you have completed all connections, check them again to make sure they are correct.
- The jack names correspond to the names on the input selector.

■ Connecting to digital jacks

This unit has digital jacks for direct transmission of digital signals through either coaxial or fiber optic cables. You can use the digital jacks to input PCM, Dolby Digital and DTS bitstreams. Use digital connections if you wish to enjoy the multi-channel sound track of DVD material, etc. with DSP effects. All digital input jacks are acceptable for 96 kHz sampling digital signals.

Note

- The OPTICAL jacks on this unit conform to the EIA standard. If you use a fiber optic cable that does not conform to this standard this unit may not function properly.

DIGITAL INPUT jacks
(pages 9 – 12)

This jack is reserved for factory use.
Do not connect any equipment to this jack.

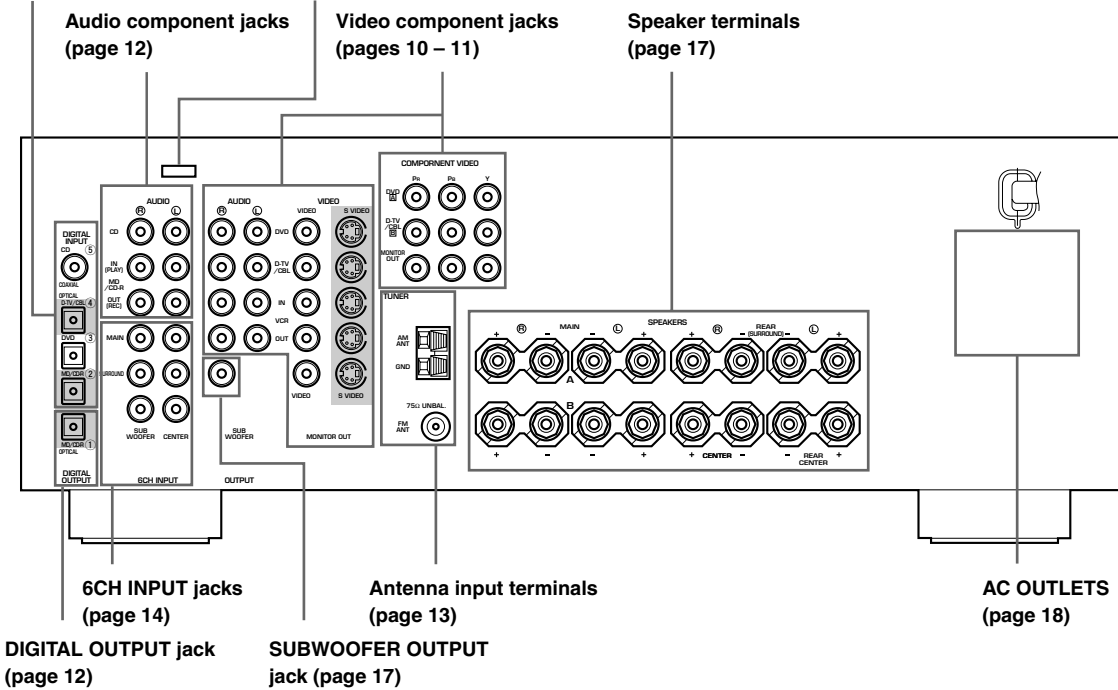

All illustrations of the rear panel in this manual are based on the RX-V540. The jacks in the shaded area in this illustration are not present on the RX-V440.

Connecting video components

Refer to the connection examples on the next page.

Types of video jacks

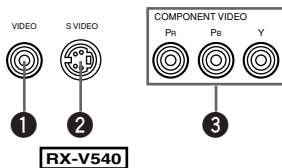

1 VIDEO jack

Conventional composite video signal.

2 S VIDEO jack RX-V540

Transmits color and luminance separately and achieves high-quality color reproduction.

3 COMPONENT VIDEO jacks

Transmit color difference (P_B, P_R) and luminance separately and provide the best quality picture.

Use the commercially available cable type specified for connecting each jack.



- You can designate the input for the COMPONENT VIDEO A and B jacks to suit your components by using "INPUT 1 I/O ASSIGNMENT" on the set menu.

RX-V540

- Signals received through the S VIDEO input jacks can be converted to composite signals in this unit and output through its VIDEO MONITOR OUT as well.
- (With the exception of China and General models) Signals received through the VIDEO jack on this unit can be output through the S VIDEO MONITOR OUT jack by setting "V CONV." in "OPTION 1 DISPLAY SET" on the set menu to ON.
- When the unit receives signals through both S VIDEO and VIDEO jacks, signals input through the S VIDEO jack have priority.

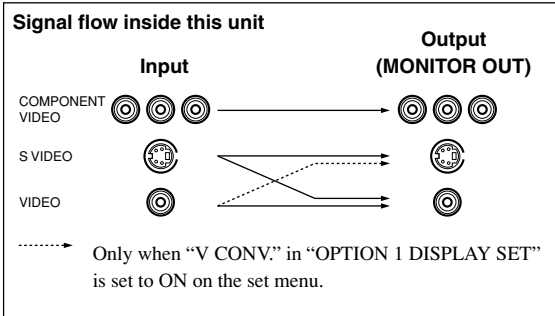

Connecting a video monitor

Connect the video input jack on your video monitor to the MONITOR OUT VIDEO jack.

Note

- If you connect this unit with a source component using Component video jacks, you also need to connect your video monitor using Component video jacks.

Connecting a DVD player/digital TV/cable TV

Connect the optical digital audio signal output jack on your component to the DIGITAL INPUT jack and connect the video signal output jack on the component to the VIDEO jack on this unit.

Note

RX-V440

- The unit has only one DIGITAL INPUT jack, for use with a DVD player.



- Use the AUDIO jacks on this unit for a video component which does not have optical digital output jack. However, multi-channel reproduction cannot be obtained with audio signals input from the AUDIO jacks.

Connecting a recording component

Connect the audio signal input jacks on your video component to the AUDIO OUT jacks on this unit. Then connect the video signal input jack on the video component to the VIDEO OUT jack on this unit for picture recording.

Connect the audio signal output jacks on your component to the AUDIO IN jacks on this unit. Then connect the video signal output jack on the component to the VIDEO IN jack on this unit to play a source from your recording component.

Note

- Once you have connected a recording component to this unit, keep its power turned on while using this unit. If the power is off, this unit may distort the sound from other components.

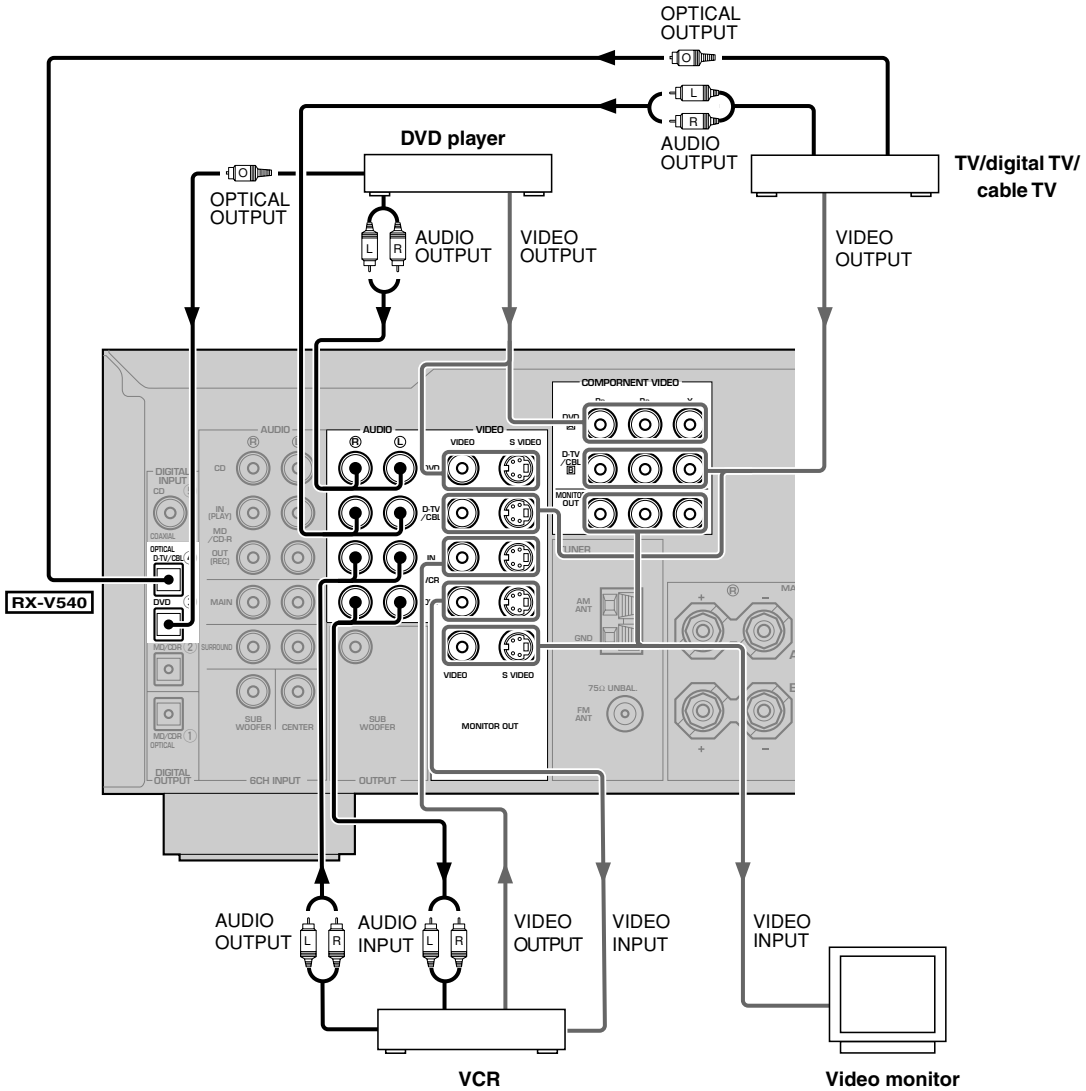

- indicates audio signal direction
- indicates left analog cables
- indicates right analog cables
- indicates optical cables
- indicates video signal direction

PREPARATION

English

Connecting audio components

■ Connecting a CD player

Connect the coaxial digital output jack on your CD player to the DIGITAL INPUT CD jack on this unit.



- Use the AUDIO jacks on this unit for a CD player which does not have coaxial digital output jack.

■ Connecting a CD recorder or MD recorder

RX-V540

Connect the optical digital signal input jack on your CD recorder or MD recorder to the DIGITAL OUTPUT MD/CD-R jack on this unit for digital recording.

Connect the optical digital output jack on your CD recorder or MD recorder to the DIGITAL INPUT MD/CD-R jack on this unit to play a source from your recording component.

RX-V440

Connect the input jacks on your CD recorder or MD recorder to the MD/CD-R OUT (REC) jacks for analog recording.

Connect the output jacks on your CD recorder or MD recorder to the MD/CD-R IN (PLAY) jacks to play a source from your recording component.



- Use the AUDIO jacks on this unit for a CD recorder or MD recorder which does not have optical digital input or output jack.

Notes

- Once you have connected a recording component to this unit, keep its power turned on while using this unit. If the power is off, this unit may distort the sound from other components.

RX-V540

- The DIGITAL OUTPUT jack and analog OUT (REC) jacks are independent. The DIGITAL OUTPUT jack only outputs digital signals, while the OUT (REC) jacks output analog signals only.

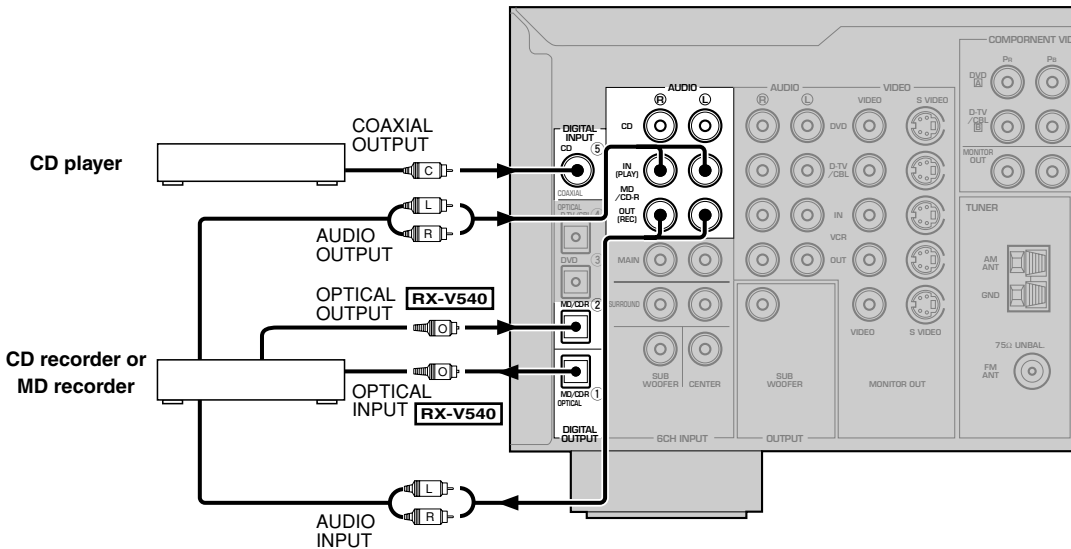

- indicates signal direction
- indicates left analog cables
- indicates right analog cables
- indicates coaxial cables
- indicates optical cables

Connecting the antennas

Both AM and FM indoor antennas are included with this unit. In general, these antennas should provide sufficient signal strength.

Connect each antenna correctly to the designated terminals.

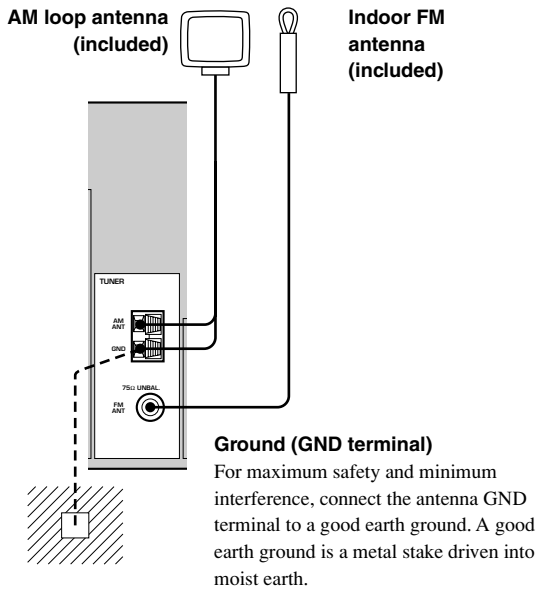

75-ohm/300-ohm antenna adapter (U.K. model only)

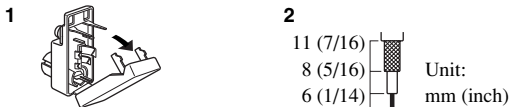

Open the cover of the included 75-ohm/300-ohm antenna adapter.

Cut the external sleeve of the 75-ohm coaxial cable and prepare it for connection.

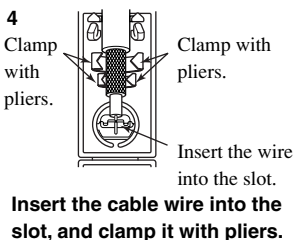
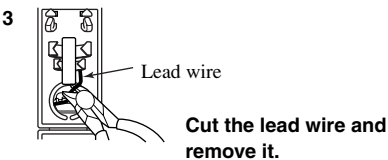

■ Connecting the AM loop antenna

1 Set up the AM loop antenna, then connect it to the terminals on this unit.

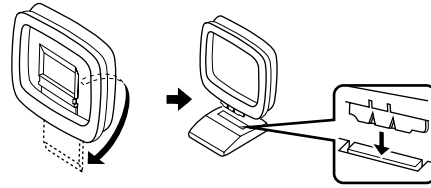

2 Press and hold the tab to insert the AM loop antenna lead wires into the AM ANT and GND terminals.

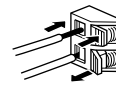

3 Orient the AM loop antenna for the best reception.



Notes

- The AM loop antenna should be placed away from this unit.
- The AM loop antenna should always be connected, even if an outdoor AM antenna is connected to this unit.

A properly installed outdoor antenna provides clearer reception than an indoor one. If you experience poor reception quality, an outdoor antenna may improve the quality. Consult the nearest authorized YAMAHA dealer or service center about the outdoor antennas.

FREQUENCY STEP switch (China and General models only)



Because the inter-station frequency spacing differs in different areas, set the FREQUENCY STEP switch (located on the rear panel) according to the frequency spacing in your area.
North, Central and South America:
100 kHz/10 kHz
Other areas: 50 kHz/9 kHz
Before setting this switch, disconnect the AC power plug of this unit from the AC outlet.

Connecting an external decoder

This unit is equipped with 6 additional input jacks (MAIN left and right, CENTER, SURROUND left and right and SUBWOOFER) for discrete multi-channel input from a component equipped with a multi-channel decoder and 6 channel output jacks such as a DVD/SACD player.

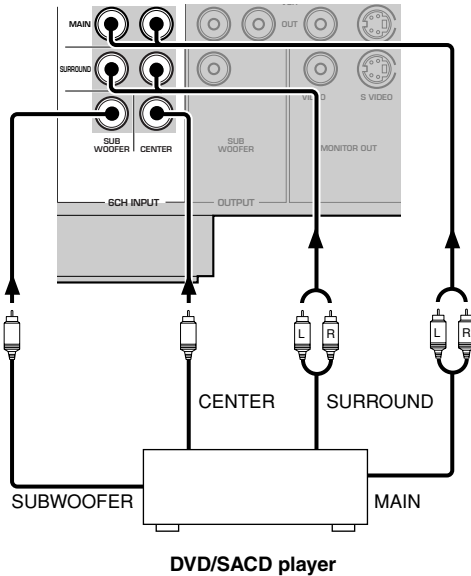

Note

- When you select 6CH INPUT as the input source, the unit automatically turns off the digital sound field processor, and you cannot use DSP programs.

Connecting the speakers

Speakers

This unit has been designed to provide the best sound-field quality with a 6-speaker system, using main left and right speakers, rear left and right speakers, a center speaker, and a rear center speaker. If you use different brands of speakers (with different tonal qualities) in your system, the tone of a moving human voice and other types of sound may not shift smoothly. We recommend that you use speakers from the same manufacturer or speakers with the same tonal quality.

The main speakers are used for the main source sound plus effect sounds. They will probably be the speakers from your present stereo system. The rear speakers are used for effect and surround sounds. The center speaker is for the center sounds (dialog, vocals, etc.). The rear center speaker supplements the rear (left and right) speakers and provides for more realistic front-to-back transitions.

The main speakers should be high-performance models and have enough power-handling capacity to accept the maximum output of your audio system. The other speakers do not have to be equal to the main speakers. For precise sound localization, however, it is ideal to use the models of equivalent performance with the main speakers.

Use of a subwoofer expands your sound field

It is also possible to further expand your system with the addition of a subwoofer. The use of a subwoofer is effective not only for reinforcing bass frequencies from any or all channels, but also for reproducing the LFE (low-frequency effect) channel with high fidelity when playing back Dolby Digital or DTS signals. The YAMAHA Active Servo Processing Subwoofer System is ideal for natural and lively bass reproduction.

Speaker placement

Refer to the following diagram when you place the speakers.

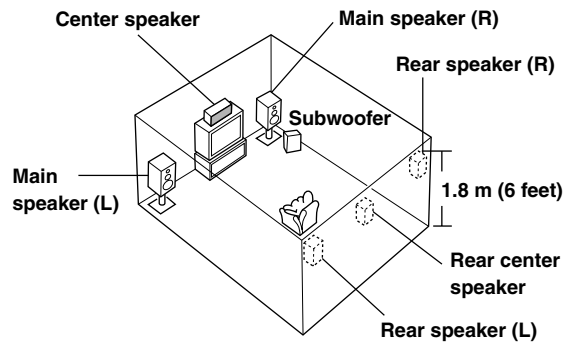

Main speakers

Place the main left and right speakers an equal distance from the ideal listening position. The distance between each speaker and each side of the video monitor should also be the same.

Center speaker

Align the front face of the center speaker with the front face of your video monitor. Place the speaker as close to the monitor as possible (such as directly over or under the monitor) and centrally between the main speakers.

Rear speakers

Place these speakers behind your listening position, facing slightly inwards, about 1.8 m (6 feet) above the floor.

Rear center speaker

Place the rear center speaker in the center between the rear left and right speakers at the same height from the floor as the rear speakers.

Subwoofer

The position of the subwoofer is not so critical, because low bass sounds are not highly directional. However, it is better to place the subwoofer near the main speakers. Turn it slightly toward the center of the room to reduce wall reflections.

Note

- If you do not use any of effect speakers (rear, center and/or rear center), change the settings of "SOUND 1 SPEAKER SET" items at the set menu to direct signals to other terminals you have connected speakers to.

CAUTION

Use magnetically shielded speakers. If these speakers still create interference with the monitor, place the speakers away from the monitor.

Connections

Be sure to connect the left channel (L), right channel (R), “+” (red) and “-” (black) in accordance with the markers on this unit, the speakers, and the speaker cables. If the connections are faulty, no sound will be heard from the speakers, and if the polarity of the speaker connections is incorrect, the sound will be unnatural and lack bass.

CAUTION

- Use speakers with the specified impedance shown on the rear panel of this unit.
- Do not let the bare speaker wires touch each other or any metal part of this unit. This could damage this unit and/or the speakers.

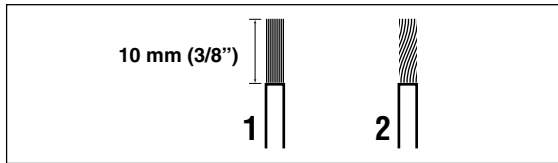

A speaker cord is actually a pair of insulated cables running side by side. One cable is colored or shaped differently, perhaps with a stripe, groove or ridge.

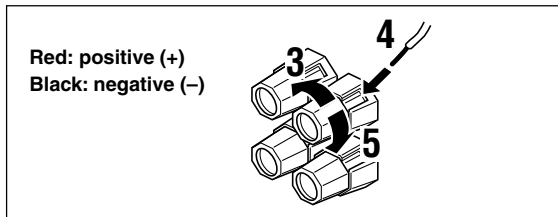

1 Remove approximately 10 mm (3/8”) of insulation from each of the speaker cables.

2 Twist the exposed wires of the cable together to prevent short circuits.

3 Unscrew the knob.

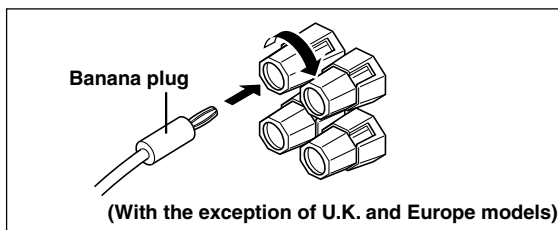

4 Insert one bare wire into the hole in the side of each terminal.

5 Tighten the knob to secure the wire.



(With the exception of U.K. and Europe models)

- You can also use banana plug connectors. First, tighten the knob and then insert the banana plug connector into the end of the corresponding terminal.

IMPEDANCE SELECTOR switch

WARNING

Do not change setting of the IMPEDANCE SELECTOR switch when the unit power is switched on, as doing so may damage the unit. If this unit fails to turn on when STANDBY/ON (or SYSTEM POWER) is pressed, the IMPEDANCE SELECTOR switch may not be fully slid to either position. If this is the case, slide the switch all the way to either position when this unit is in standby mode. Be sure to move this switch only when this unit is in standby mode.

Select the switch position (left or right) according to the impedance of the speakers in your system.

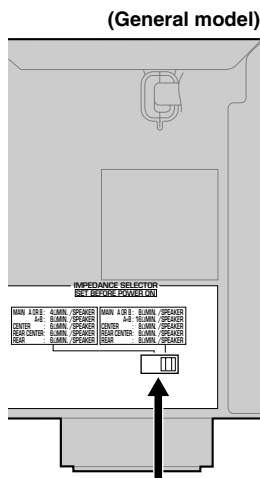

Switch position	Speaker	Impedance level
Left	Main	If you use one/two set(s) of main speakers, the impedance of each speaker must be 4 Ω/8 Ω or higher.
	Center, Rear Center, Rear	The impedance of each speaker must be 6 Ω or higher.
Right	Main*	If you use one/two set(s) of main speakers, the impedance of each speaker must be 8 Ω/16 Ω or higher.
	Center, Rear Center, Rear	The impedance of each speaker must be 8 Ω or higher.

* [Canada model only]
When the switch is set to right, you cannot use “A+B”.

IMPEDANCE SELECTOR switch

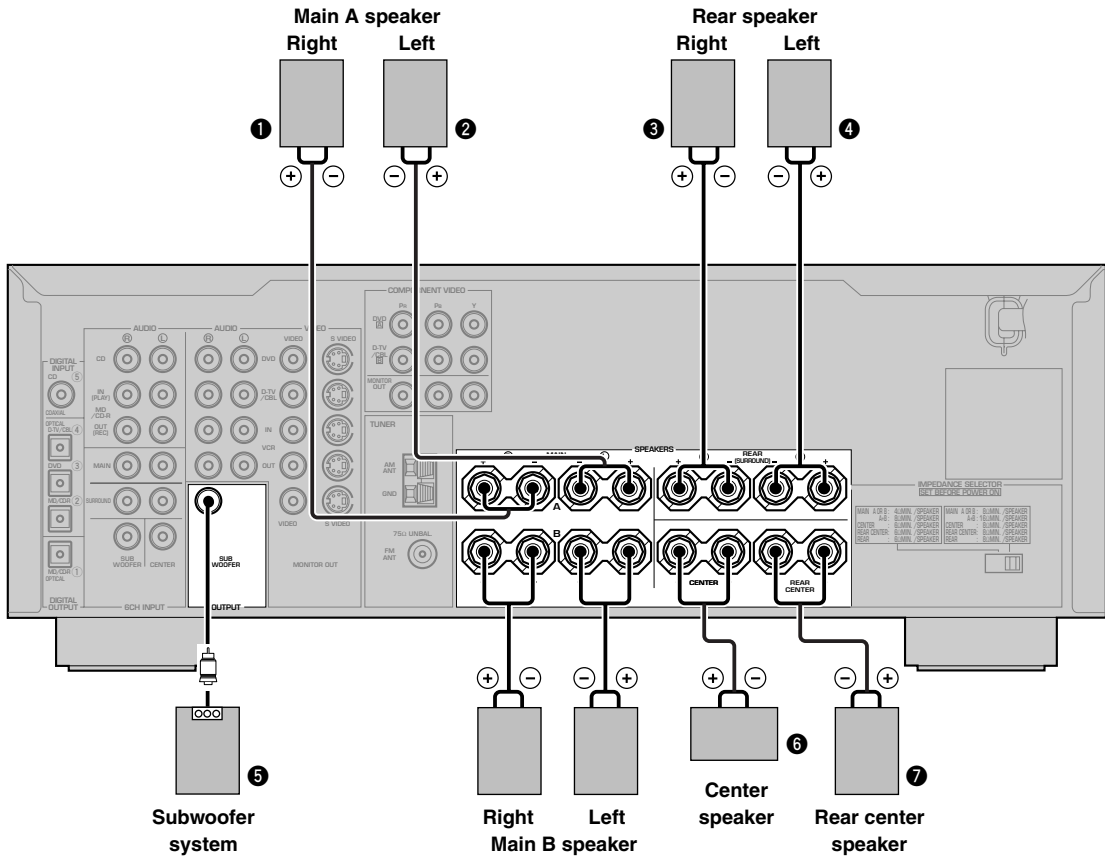

PREPARATION

MAIN SPEAKERS terminals

You can connect up to two speaker systems to these terminals. When using only one speaker system, connect it to either of the MAIN A or the MAIN B terminals.

REAR SPEAKERS terminals

A rear speaker system can be connected to these terminals.

CENTER SPEAKER terminals

A center speaker can be connected to these terminals.

REAR CENTER SPEAKER terminals

A rear center speaker can be connected to these terminals.

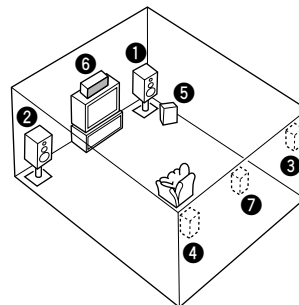

The diagram shows the speaker layout in the listening room.

SUBWOOFER jack

When using a subwoofer with built-in amplifier, including the YAMAHA Active Servo Processing Subwoofer System, connect the input jack of the subwoofer system to this jack. This unit will direct low bass signals distributed from the main, center and/or rear channels to this jack in accordance with your SPEAKER SET selections. The LFE (low-frequency effect) signals generated when Dolby Digital or DTS is decoded are also directed to this jack in accordance with your SPEAKER SET selections.

Notes

- The cut-off frequency of the SUBWOOFER jack is 90 Hz.
- If you do not use a subwoofer, allocate the signals to the main left and right speakers by changing the setting of "SOUND 1 SPEAKER SET" item "1E BASS" on the set menu to MAIN.
- Use the control on the subwoofer to adjust its volume level. You can also adjust the volume level by using this unit's remote control (see "SETTING THE SPEAKER LEVELS" on page 48).

English

Connecting the power supply cords

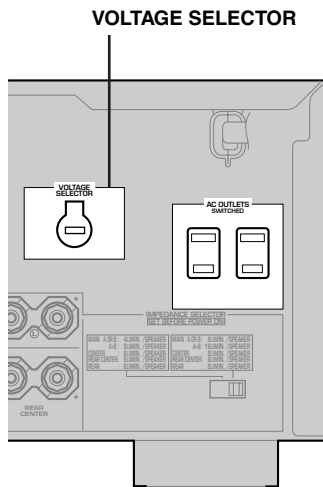

(General model)

■ Connecting the AC power cord

Plug in this unit to a wall outlet.

■ AC OUTLETS (SWITCHED)

U.S.A., Canada, China, Europe, Singapore and General models 2 OUTLETS
U.K. and Australia model 1 OUTLET

Use these outlets to connect the power cords from your components to this unit. The power to the AC OUTLETS is controlled by this unit's STANDBY/ON (or SYSTEM POWER and STANDBY). These outlets will supply power to any source component connected to this unit whenever this unit is turned on. The maximum power (total power consumption of components) that can be connected to the AC OUTLETS varies depending on the area which it was purchasing.

China and General models 50 W
Other models 100 W

■ VOLTAGE SELECTOR (China and General models only)

The VOLTAGE SELECTOR on the rear panel of this unit must be set for your local main voltage BEFORE plugging into the AC main supply. Voltages are 110/120/220/240 V AC, 50/60 Hz.

Turning on the power

When all connections are complete, turn on the power of this unit.

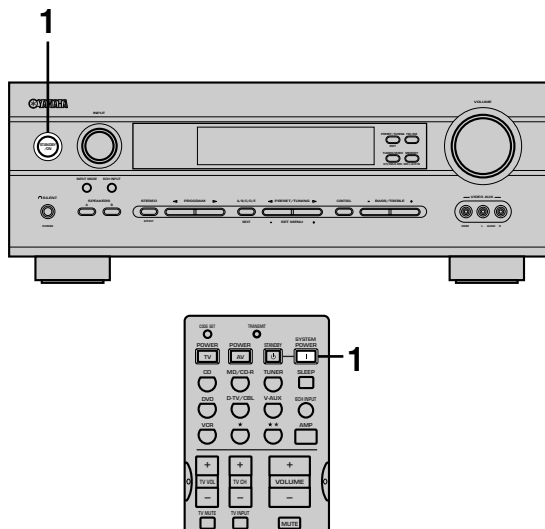

1 Press STANDBY/ON (SYSTEM POWER on the remote control) to turn on the power of this unit.



Front panel

or



Remote control

The level of the main volume, and then the current DSP program name appear on the front panel display.

BASIC SYSTEM SETTINGS

The “BASIC” menu allows you to set some of the basic “SOUND” menu parameters with a minimum of effort. If you wish to configure the unit more precisely to suit your listening environment, use the more detailed parameters from the “SOUND” menu instead of those under the “BASIC” menu (See page 39). Altering any parameters in the BASIC menu will reset all parameters in the “SOUND” menu.

Using the basic menu

Use the remote control to make adjustments.

- Press SPEAKERS A or B on the front panel to select the main speakers you want to use.
- Make sure you disconnect headphones from this unit.

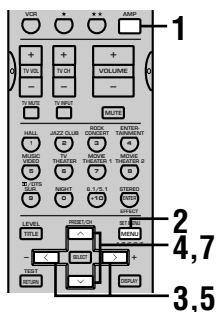

- 1** Press AMP.



- 2** Press SET MENU.

“BASIC MENU” appears on the front panel display, as shown here.



If the front panel display changes to show anything other than “BASIC MENU”, press \wedge until it displays “BASIC MENU”.

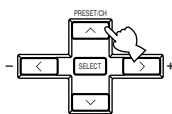

- 3** Press \langle / \rangle to enter into the BASIC menu.

The front panel display changes as shown here:

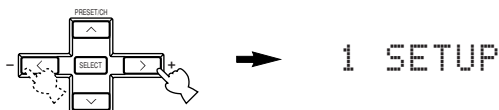

- 4** Press \wedge / \vee to change the display to the setting you want to alter.

SETUP

Changes the speaker and amplifier settings to suit the size of the room you are using. Refer to “Setting the unit to match your speaker system” for more information.

SP LEVEL

Adjusts the output levels of the speakers. Refer to “Setting speaker output levels” for more information.

- 5** Press \langle / \rangle to enter the desired setting mode.

- 6** Change the unit settings to suit your listening environment. When you have finished, the unit will automatically return to the basic menu.

- 7** Press \wedge / \vee to exit from the set menu.

The front panel display changes in the following order:

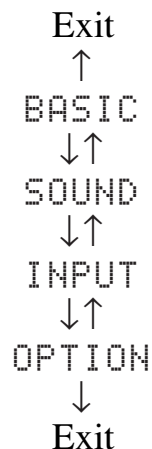
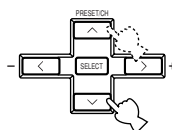

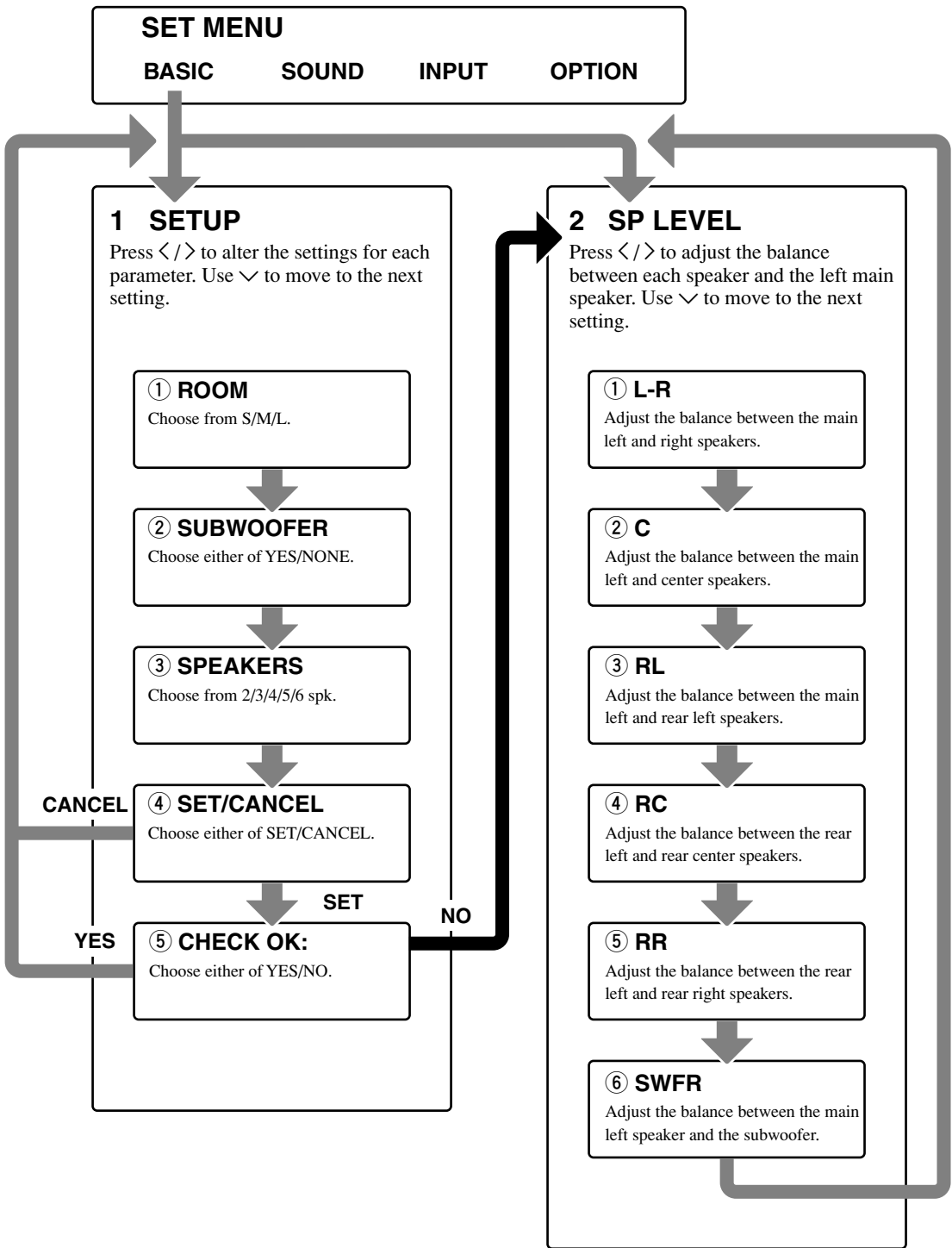

- After altering the “1 SETUP” parameters, readjust the output levels of the speakers at “2 SP LEVEL”.
- See pages 38 – 44 for a detailed explanation of the “SOUND”, “INPUT” and “OPTION” menus.

Setting the unit to match your speaker system

Follow the instructions below to set the amplifier output to match the size of your room and speakers. Press \wedge / \vee to cycle through parameters 1 through 4, and \langle / \rangle to alter the parameter setting.

Factory default settings are highlighted.

① ROOM

Settings: S, M, L

Select the size of the room you have installed your speakers in. Roughly speaking, the room sizes are defined as follows:

[U.S.A. and Canada models]

S: 16ft. x 3ft., 200sq.ft. (4.8 x 4m, 20m²)

M: 20ft. x 16ft., 300sq.ft. (6.3 x 5.0m, 30m²)

L: 26ft. x 19ft., 450sq.ft. (7.9 x 5.8m, 45m²)

[Other models]

S: 3.6m x 2.8m, 10m²

M: 4.8m x 4.0m, 20m²

L: 6.3m x 5.0m, 30m²

② SUBWOOFER

Settings: YES, NONE

Select YES if you have a subwoofer in your system, or NONE if you do not.

③ SPEAKERS

Settings: 2, 3, 4, 5, 6 (spk)

Select the number of speakers you wish to use in your speaker configuration. This number does not include your subwoofer.

Setting	Display	Speaker
2spk	L R	Main L/Main R
3spk	L C R	Main L/Center/Main R
4spk	L R RL RR	Main L/Main R/Rear L/ Rear R
5spk	L C R RL RR	Main L/Center/Main R/ Rear L/Rear R
6spk	L C R RL RC RR	Main L/Center/Main R/ Rear L/Rear Center/Rear R

④ SET or CANCEL

Select SET to confirm the changes you made to the above three settings. The unit will output a test tone to the speakers (see ⑤). Alternatively, select CANCEL to exit this menu without altering any of the unit settings.

⑤ Use the test tone to check the speaker levels.

When you select SET in ④, the display changes to “CHECK: TestTone”, and the unit outputs a test tone to each of the speakers in turn. When the test tone begins, the display changes to “CHECK OK: YES”.

If the volume of the test tone varies between speakers, press \langle / \rangle to change the display to “NO”. The unit will automatically enter the “2 SP LEVEL” mode.

If the test tone is output at the same volume from all of the speakers, select “CHECK OK: YES”. The unit will exit from the SETUP menu.

Notes

- The unit cycles the test tone around each of the speakers in turn twice.
- The indicator of the speaker currently outputting the test tone flashes on the front panel display.

Setting speaker output levels (SP LEVEL)

Use this menu to compare and adjust the test tone output from each speaker to the output from the left main (or left rear) speaker so that the volume level for all speakers is identical. Press \wedge / \vee to select a speaker, then adjust the balance using \langle / \rangle .

Note

- The unit outputs the test tone from the selected speaker and the left main (or left rear) speaker in turn. The indicator of the speaker currently outputting the test tone flashes on the front panel display.

① L-R

Adjusts the balance between the main left and right speakers.

② C

Adjusts the balance between the main left and center speakers.

③ RL

Adjusts the balance between the main left and rear left speakers.

④ RC

Adjusts the balance between the rear left and rear center speakers.

⑤ RR

Adjusts the balance between the rear left and rear right speakers.

⑥ SWFR

Adjust the balance between the main left speaker and the subwoofer.

PLAYBACK

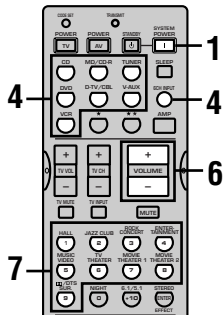
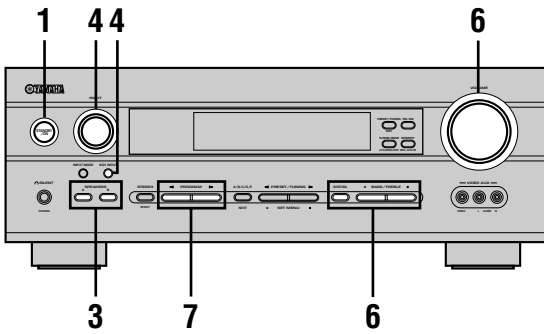

- 1** Press **STANDBY/ON** (SYSTEM POWER on the remote control) to turn on the power.

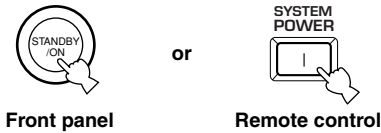

- 2** Turn on the video monitor connected to this unit.

- 3** Press **SPEAKERS A** or **B** to select the main speakers you want to use.

If you are using two sets of main speakers, press both A and B.

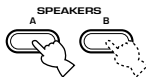

- 4** Rotate the **INPUT** selector (or press one of the input selector buttons on the remote control) to select the input source.

The selected input source name and input mode appear on the front panel display for a few seconds.

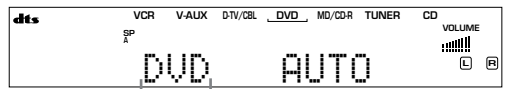
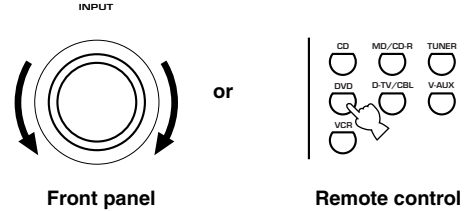

Selected input source

To select the audio source connected to the 6CH INPUT jacks

- Select the input to which the video source component is connected before selecting an audio source. Press **6CH INPUT** until “6CH INPUT” appears on the front panel display.

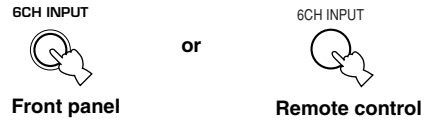

6CH INPUT

Note

- If “6CH INPUT” is shown on the front panel display, no other source can be played. To select another input source, first press **6CH INPUT** so that “6CH INPUT” disappears from the front panel display.

5 Start playback or select a broadcast station on the source component.

Refer to the operation instructions for the component.

6 Adjust the volume to the desired level.

The volume level is displayed digitally.

Example: -70 dB

Control range: VOLUME MUTE (minimum) to 0 dB (maximum)

The volume level indicator also shows the current volume level as a bar graph.

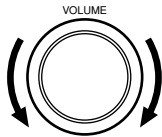

Front panel

or

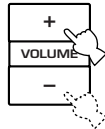

Remote control

If desired, use CONTROL and BASS/TREBLE $-/+$. These controls only effect the sound from the main speakers.

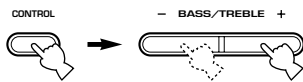

Front panel

Notes

- If you increase or decrease the high-frequency or the low-frequency sound to an extreme level, the tonal quality from the center and rear speakers may not match that of the main left and right speakers.
- If you have connected a recording component to the VCR OUT, or MD/CD-R OUT jacks, and you notice distortion or low volume during playback from other components, try turning the recording component on.

7 Select a DSP program if desired.

Use PROGRAM $\triangleleft/\triangleright$ (DSP program buttons on the remote control) to select a DSP program. See pages 28 – 30 for details about DSP programs. When using the remote control, press AMP before selecting a DSP program.

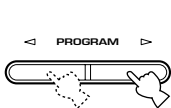

Front panel

or

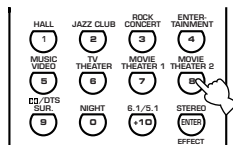

Remote control

■ BGV (background video) function

The BGV function allows you to view images from a video source together with sounds from an audio source. For example, you can enjoy listening to classical music while watching beautiful scenery from a video source on the video monitor.

Select a source from the video group, then select a source from the audio group using the input selector buttons on the remote control.

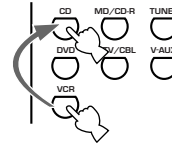

■ To mute the sound

Press MUTE on the remote control.

To resume audio output, press MUTE again.



- You can change the amount by which the unit reduces the volume in "OPTION 3 AUDIO MUTE" in the set menu.
- You can also cancel mute by pressing VOLUME $+/-$, etc.
- During muting, the MUTE indicator flashes on the front panel display.

■ Night listening mode

This mode reproduces dialogue clearly while reducing the volume of loud sound effects for easier listening at low volumes or at night.

Press NIGHT on the remote control.

Press NIGHT once more to return to normal reproduction.



Note

- Setting the unit in standby mode cancels night listening mode.
- You can use night listening mode with any of the sound field programs.
- The NIGHT indicator on the front panel display lights when the unit is in night listening mode.
- Night listening mode may vary in effectiveness depending on the input source and surround sound settings you use.

■ When you have finished using this unit

Press STANDBY/ON (STANDBY on the remote control) to set this unit in standby mode.



Front panel

or



Remote control

Input modes and indications

This unit is equipped with a variety of input jacks. You can select the type of input signals you wish to use.

Each time you turn on the unit power, the input mode is set to the "INPUT 2 INPUT MODE" setting defined in the set menu.

Press INPUT MODE repeatedly until the desired input mode is shown on the front panel display.

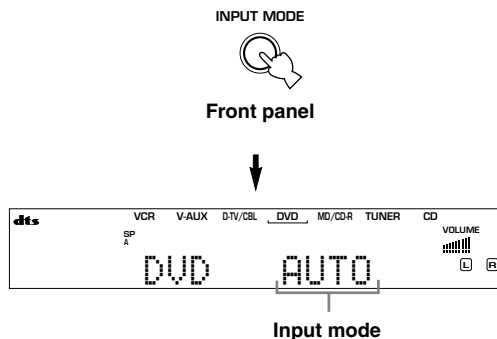

- AUTO:** In this mode, the input signal is selected automatically as follows:
- 1) Digital signal
 - 2) Analog signal
- DTS:** In this mode, only digital input signals encoded with DTS are selected, even if the unit is receiving another signal simultaneously.
- ANALOG:** In this mode, only analog input signals are selected, even the unit is receiving digital signals at the same time.

Notes

- When AUTO is selected, this unit automatically determines the type of signal. If it detects a Dolby Digital or DTS signal, the decoder automatically switches to the appropriate setting.
- When playing a disc encoded with Dolby Digital or DTS on some LD or DVD players, there is a delay in sound output for a moment when playback resumes after a search, because the unit must select the digital signal again.
- When playing a LD source that has not been digitally recorded, the unit may not output any sound for some LD players. In this case, set the input mode to ANALOG.

Notes on digital signals

The digital input jacks of this unit can handle 96 kHz sampling digital signals. Note the following when a digital signal with a sampling frequency greater than 48 kHz is input to this unit:

- You cannot use any DSP programs.
- The unit will output sound as 2-channel stereo from the main left and right speakers only. Therefore, you cannot adjust the level of the effect speakers while listening to such a source.

Notes on playing DTS-CD/LDs

- If the digital output data of the player has been processed in any way, the unit may not be able to perform DTS decoding even if there is a digital connection between this unit and the player.
- If you play a source encoded with a DTS signal and set the input mode to ANALOG, the unit may reproduce the noise of an unprocessed DTS signal. In this case, connect the source to a digital input jack on this unit and set the input mode to AUTO or DTS.
- If you switch the input mode to ANALOG while playing a source encoded with a DTS signal, the unit does not output any sound.
- If you play a source encoded with a DTS signal with the input mode set to AUTO;
 - The unit automatically switches to the DTS-decoding mode (The "dts" indicator lights up) after detecting the DTS signal. When playback of the DTS source is completed, the "dts" indicator may flash. While this indicator is flashing, the unit can only reproduce DTS source. If you want to play a normal PCM source immediately, change the input mode back to AUTO.
 - When the input mode is set to AUTO and a search or skip operation is performed during playback of a DTS source, the "dts" indicator may flash. If this state continues for longer than 30 seconds, the unit will automatically switch from "DTS-decoding" mode to PCM digital signal input mode. The "dts" indicator will turn off.

Selecting a sound field program

You can enhance your listening experience by selecting a DSP program. For details about each program, see pages 28 – 30.

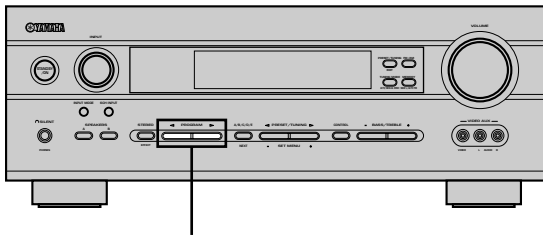

PROGRAM ◀/▶

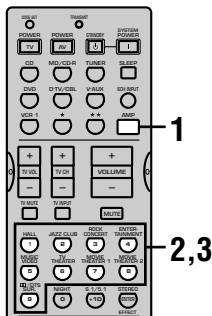

1 Press AMP.



2 Press one of the numeric buttons on the remote control to select the desired program.

The name of the selected program appears on the front panel display.

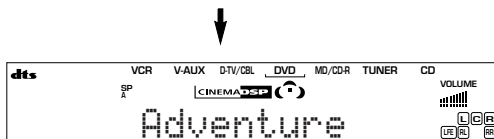
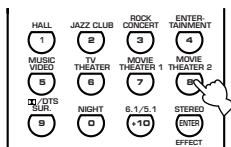

3 After selecting the desired program, press the same button repeatedly to cycle through sub-programs if available.

Example: Pressing MOVIE THEATER 2 repeatedly switches the sub-program between “Adventure” and “General”.

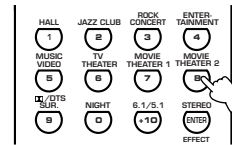

Notes

- There are 9 programs with sub-programs available with this unit. However, the selection depends on the input signal format and not all sub-programs can be used with all input signal formats.
- You cannot use the digital sound field processor with a source connected to the 6CH INPUT jacks of this unit or when the unit is reproducing a digital source with a sampling frequency greater than 48 kHz.
- The acoustics of your listening room affect the DSP program. Minimize the sound reflections in your room to maximize the effect created by the program.
- When you select an input source, this unit automatically selects the last DSP program used with that source.
- When you set this unit in standby mode, it stores the current source and DSP program in memory and automatically selects them when you turn on the power again.
- If the unit receives a Dolby Digital or DTS signal when the input mode is set to AUTO, the DSP program (No. 7–9) automatically switches to the appropriate decoding program.
- When the unit is reproducing a monaural source with PRO LOGIC or PRO LOGIC/Enhanced, or PRO LOGIC II Movie, no sound is output from the main and rear speakers. Sound can only be heard from the center speaker. (If “1A CENTER” on the set menu is set to NON, the center channel sound is output from the main speakers.)



- You can also select DSP program by pressing PROGRAM ◀/▶ on the front panel.
- Select a program based on your listening preference. Program names are just for reference.

■ Selecting PRO LOGIC, PRO LOGIC II or Neo:6

You can listen to 2-channel sources decoded into five or six discrete channels by selecting PRO LOGIC, PRO LOGIC II or Neo:6 in program No. 9.

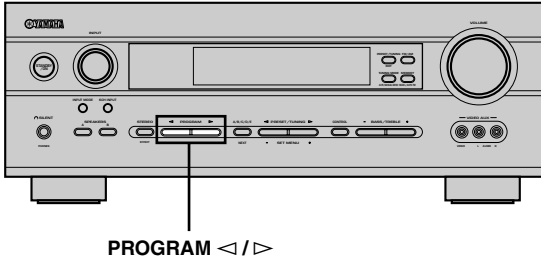

PROGRAM </>/>

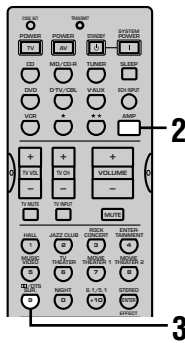

1 Select a 2-channel source and start playback on the source component.

2 Press AMP.



3 Press DTS/DTS SUR.

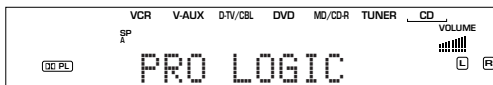
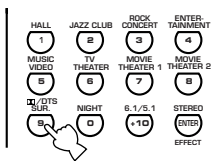

The display cycles as follows each time you press DTS/DTS SUR :

PRO LOGIC→PRO LOGIC Enhanced→PRO LOGIC II Movie→PRO LOGIC II Music→Neo:6 Cinema→Neo:6 Music→PRO LOGIC→...



- You can select PRO LOGIC, PRO LOGIC Enhanced, PRO LOGIC II Movie, PRO LOGIC II Music, Neo:6 Cinema, and Neo:6 Music by pressing PROGRAM </>/> on the front panel repeatedly.

■ Playing Dolby Digital EX or DTS ES material

Press 6.1/5.1 to turn on the Dolby Digital EX or DTS ES decoder to listen to Dolby Digital EX and DTS ES material with a rear center speaker.

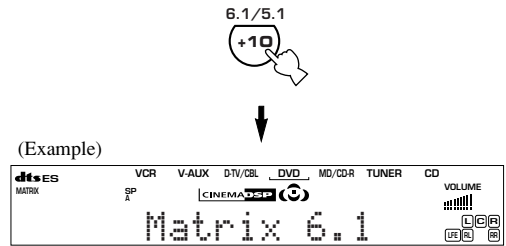

Press 6.1/5.1 to choose the playback mode. (The modes you can select vary depending on the format of the material you are playing.)

AUTO: This mode automatically switches to Dolby Digital EX/DTS ES Matrix 6.1/DTS ES Discrete 6.1 depending on the signal in the input source that the unit detects. The rear center speaker does not output sound for 5.1 channel sources.

Discrete 6.1: This mode can only be selected only when the unit detects a source encoded with the DTS ES Discrete format. (The DISCRETE indicator lights up.)

Matrix 6.1: This mode allows for 6-channel playback of the input source through the Matrix 6.1 decoder. (Either DOLBY DIGITAL EX or MATRIX indicator lights up.)

OFF: The rear center speaker does not output sound in this mode.

Notes

- Some 6.1-channel compatible discs do not have a signal (flag) that this unit can automatically detect. Select "Matrix 6.1" to play these kinds of discs with 6.1-channel sound.
- 6.1-channel playback is not possible even if you press 6.1/5.1 in the following cases:
 - When "1C REAR LR" is set to NON.
 - When effects are turned off.
 - When the source connected to the 6CH INPUT jack is being played.
 - When the unit is reproducing a Dolby Digital KARAOKE source.
 - When headphones are connected to the PHONES jack.
- The input mode resets to AUTO when you turn the unit power off.

■ Virtual CINEMA DSP

With Virtual CINEMA DSP, you can enjoy all DSP programs without rear speakers. It creates virtual speakers to reproduce a natural sound field.

You can listen to virtual CINEMA DSP by setting “1C REAR LR” in the set menu to NON. Sound field processing changes to VIRTUAL CINEMA DSP automatically.

Note

- This unit is not set in the virtual CINEMA DSP mode even if “1C REAR LR” is set to NON in the following cases:
 - when the 6ch Stereo, DOLBY DIGITAL, Pro Logic II, or DTS program is selected;
 - when the sound effect is turned off;
 - when 6CH INPUT is selected as the input source;
 - when a digital signal with a sampling frequency greater than 48 kHz is input to this unit;
 - when using the test tone; or
 - when connecting the headphones.

■ SILENT CINEMA DSP

You can enjoy a powerful sound field similar to what you could expect from actual speakers through headphones, with SILENT CINEMA DSP. You can listen to SILENT CINEMA DSP by connecting your headphones to the PHONES jack while the digital sound field processor is on. The “SILENT” indicator lights up on the front panel display. (When sound effects are off, the unit reproduces the source in normal stereo.)

Notes

- This feature is not available when 6CH INPUT is selected or the unit is receiving a digital signal with a sampling frequency greater than 48 kHz.
- The sound from the LFE channel will be mixed and output from the headphones.

■ Normal stereo reproduction

Press STEREO/EFFECT to turn off the sound effect for normal stereo reproduction.

Press STEREO/EFFECT again to turn the sound effect back on.

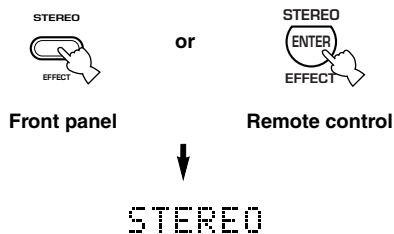

Notes

- If you turn off the sound effects, no sound is output from the center speaker, rear speakers, or rear center speaker.
- If you turn off the sound effects while the unit is reproducing sound from a Dolby Digital or DTS signal, the dynamic range of the signal is automatically compressed and the unit will output mix the sounds of the center and rear speaker channels and output them from the main speakers.
- The volume may be greatly reduced when you turn off the sound effects or if you set “SOUND 4 D. RANGE (dynamic range)” on the set menu to MIN. In this case turn on the sound effect.



- During stereo reproduction, you can display information such as the type, format and sampling frequency of the signal input from the components connected to this unit.

(While playing a source)

1 Press AMP.

2 Press \checkmark to display the information about the input signal.

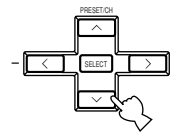

(Format): The display shows the signal format. When the unit cannot detect a digital signal it automatically switches to analog input.

in: The display shows the number of input signal source channels, as follows: For multi-channel soundtrack such as front 3 channels, rear 2 channels and LFE, the display shows “3/2/LFE”.

For bilingual broadcasts where the signal is split into 2 channels, the display shows “1+1”.

For signals with more than 3 channels the display shows “MLT”.

fs: The display shows the sampling frequency.

When the unit is unable to detect the sampling frequency “Unknown” shows in the front panel display.

rate: The display shows the bit rate. When the unit is unable to detect the bit rate “Unknown” shows in the front panel display.

flg: The display shows the flag - data encoded in a DTS or Dolby Digital signal that causes this unit to automatically switch to the appropriate decoder for playback.

DIGITAL SOUND FIELD PROCESSING (DSP)

Understanding sound fields



A sound field is defined as the “characteristic sound reflections of a particular space.” In concert halls and other music venues, we hear early reflections and reverberations as well as the direct sound produced by the artist(s). The variations in the early reflections and other reverberations among the different music venues is what gives each venue its special and recognizable sound quality.

YAMAHA sent teams of sound engineers all around the world to measure the sound reflections of famous concert halls and music venues, and collect detailed sound field information such as the direction, strength, range, and delay time of those reflections. Then we stored this enormous amount of data in the ROM chips of this unit.

■ **Recreating a sound field**

Recreating the sound field of a concert hall or an opera house requires localizing the virtual sound sources in your listening room. The traditional stereo system that uses only two speakers is not capable of recreating a realistic sound field. YAMAHA’s DSP requires four effect speakers to recreate sound fields based on the measured sound field data. The processor controls the strength and delay time of the signals output from the four effect speakers to localize the virtual sound sources and fully encompass the listener.

Hi-Fi DSP programs

The following list gives you a brief description of the sound fields produced by each of the DSP programs. Keep in mind that most of these are precise digital recreations of actual acoustic environments.

No.	Program	Features
1	CONCERT HALL	A large round concert hall with a rich surround effect. Pronounced reflections from all directions emphasize the extension of sounds. The sound field has a great deal of presence, and your virtual seat is near the center, close to the stage.
2	JAZZ CLUB	This is the sound field at stage front in “The Bottom Line”, a famous New York jazz club, that seats up to 300 people. Its wide left to right seating arrangement offers a real and vibrant sound.
3	ROCK CONCERT	The ideal program for lively, dynamic rock music. The data for this program was recorded at LA’s “hottest” rock club. The listener’s virtual seat is at the center-left of the hall.
4	ENTERTAINMENT/ Disco	This program recreates the acoustic environment of a lively disco in the heart of a big city. The sound is dense and highly concentrated. It is also characterized by a high-energy, “immediate” sound.
	ENTERTAINMENT/ 6ch Stereo	Using this program increases the listening position range. This is a sound field suitable for background music at parties, etc.

CINEMA-DSP

Sound design of CINEMA-DSP

Filmmakers intend for the dialog to be located right on the screen, the effect sound a little farther back, the music spread even farther back, and the surround sound around the listener. Of course, all of these sounds must be synchronized with the images on the screen.

CINEMA-DSP is an upgraded version of YAMAHA DSP specially designed for movie soundtracks. CINEMA-DSP integrates the DTS, Dolby Digital, and Dolby Pro Logic surround sound technologies with YAMAHA DSP sound field programs to provide a surround sound field. It recreates comprehensive movie sound design in your audio room. In CINEMA-DSP sound field programs, YAMAHA's exclusive DSP processing is added to the Main left and right, and Center channels, so the listener can enjoy realistic dialogue, depth of sound, smooth transition between sound sources, and a surround sound field that goes beyond the screen.

When a DTS or Dolby Digital signal is detected, the CINEMA-DSP sound field processor automatically chooses the most suitable sound field program for that signal.

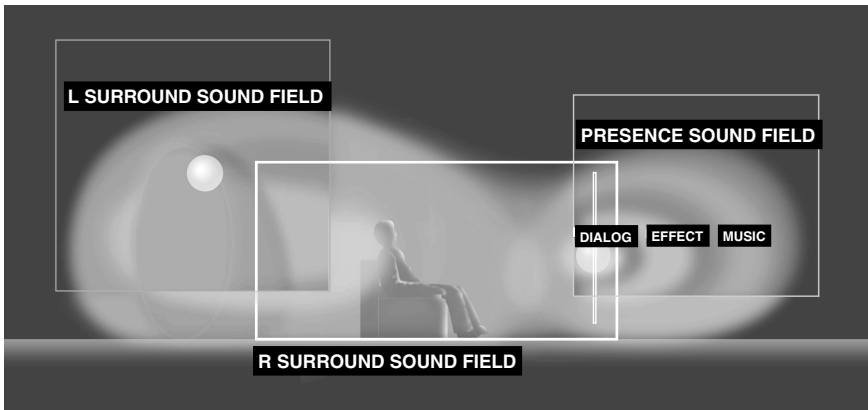

In addition to the DSP, this unit is equipped with a variety of precise decoders; Dolby Pro Logic decoder for Dolby Surround sources, Dolby Pro Logic II decoder for Dolby Surround and 2-channel sources, Dolby Digital/DTS decoder for multi-channel sources and Dolby Digital EX or DTS-ES decoder for adding a rear center channel. You can select CINEMA-DSP programs to optimize these decoders and the DSP sound patterns depending on the input source.

CINEMA-DSP Programs

The following list gives you a brief description of the sound fields produced by each of the DSP programs. Keep in mind that most of these are precise digital recreations of actual acoustic environments. Select the DSP program that you feel sounds best regardless of the name and description given for it below.

■ For audio-video sources: No. 4 to 6

No.	Program	Features
4	ENTERTAINMENT/ Game	This program adds a deep and spatial feeling to video game sounds.
5	MUSIC VIDEO	This program lends an enthusiastic atmosphere to the sound, giving you the feeling you are at an actual jazz or rock concert.
6	TV THEATER/ Mono Movie	This program is provided for reproducing monaural video sources (such as old movies). The program produces the optimum reverberation to create sound depth using only the presence sound field.
	TV THEATER/Variety/ Sports	Though the presence sound field is relatively narrow, the surround sound field employs the sound environment of a large concert hall. This effect enhances the experience of watching various TV programs such as news, variety shows, music programs or sports programs.

■ For movie programs

No.	Program		Features
7	MOVIE THEATER 1	Spectacle	This program creates the extremely wide sound field of a 70-mm movie theater. It precisely reproduces the source sound in detail, making both the video and the sound field incredibly real. This is ideal for any kind of video source encoded with Dolby Surround, Dolby Digital or DTS (especially large-scale movie productions).
		Sci-Fi	This program clearly reproduces dialog and sound effects in the latest sound form of science fiction films, thus creating a broad and expansive cinematic space amid the silence. You can enjoy science fiction films in a virtual-space sound field that includes Dolby Surround, Dolby Digital and DTS-encoded software employing the most advanced techniques.
8	MOVIE THEATER 2	Adventure	This program is ideal for precisely reproducing the sound design of the newest 70-mm and multichannel soundtrack films. The sound field is made to be similar to that of the newest movie theaters, so the reverberations of the sound field itself are restrained as much as possible.
		General	This program is for reproducing sounds from 70-mm and multichannel soundtrack films, and is characterized by a soft and extensive sound field. The presence sound field is relatively narrow. It spatially spreads all around and toward the screen, restraining the echo effect of conversations without losing clarity.
9	Straight Decode		The built-in decoder reproduces source sounds and sound-effects precisely. No DSP effect is applied in this program.
	Enhanced Mode		This program ideally simulates the multi-surround speaker systems of the 35-mm film theaters. Dolby Pro Logic decoding, Dolby Digital decoding or DTS decoding and digital sound field processing create precise effects without altering the original sound orientation. The surround effects produced by this sound field wrap around the viewer naturally from the back to the left and right, and toward the screen.

Straight Decode

This unit is equipped with various precise decoders;

- Dolby Digital/DTS decoder for multi-channel reproduction of the original sound
- Dolby Digital EX/DTS ES decoder for an additional rear center channel
- Dolby Pro Logic/Pro Logic II/DTS Neo:6 decoder for multi-channel reproduction of 2-channel sources

Select any of the STRAIGHT DECODE modes in Program 9 (except for the sub-program “Enhanced.”) to use any of these decoders for reproducing the original sound without any sound effects added. In this case, no DSP effect is applied and the DSP indicator turns off.

Note

- When playing a monaural source with a CINEMA DSP program, the source signal is directed to the center channel, and the main and rear speakers output effect sounds.

Sound field effects

The 6-channel soundtracks found on 70-mm film produce precise sound field localization and rich, deep sound without using matrix processing. This unit's MOVIE THEATER programs provide the same quality of sound and sound localization that 6-channel soundtracks do. The built-in Dolby Digital or DTS decoder brings the professional-quality sound designed for movie theaters into your home. With this unit's MOVIE THEATER programs, you can use Dolby Digital or DTS technology to recreate a dynamic sound that gives you the feeling of being in a public theater.

■ Dolby Digital/DTS + DSP sound field effect

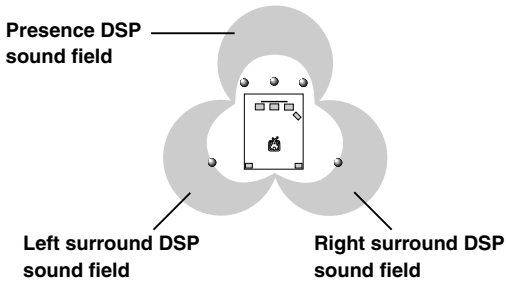

These programs use YAMAHA's tri-field DSP processing on each of the Dolby Digital or DTS signals for the front, left surround, and right surround channels. This processing enables this unit to reproduce the immense sound field and surround expression of a Dolby Digital- or DTS-equipped movie theater without sacrificing the clear separation of all channels.

■ Dolby Digital EX/DTS-ES + DSP sound field effect

These programs provide you with the maximum experience of the spacious surround effects by adding an extra rear center DSP sound field created from the rear center channel.

■ Dolby Pro Logic + DSP sound field effect

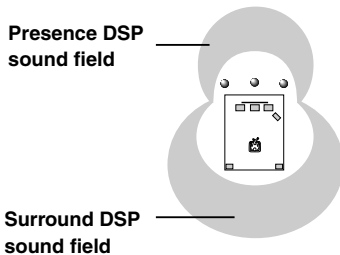

Most movie material has 4-channel (left, center, right, and surround) sound information encoded by Dolby Surround matrix processing and stored on the left and right tracks. These signals are processed by the Dolby Pro Logic decoder. The MOVIE THEATER programs are designed to recreate the spaciousness and delicate nuances of sound that tend to be lost in the encoding and decoding processes.

■ Dolby Pro Logic II/DTS Neo:6

This unit comes with Dolby Pro Logic II and DTS Neo:6 decoders which decode 2-channel Dolby Surround data into five or six full range channels. Both decoders have two modes, MOVIE/CINEMA for movies, and MUSIC for 2-channel sources.

TUNING

There are 2 methods of tuning; automatic and manual. Automatic tuning is effective when station signals are strong and there is no interference.

■ Automatic tuning

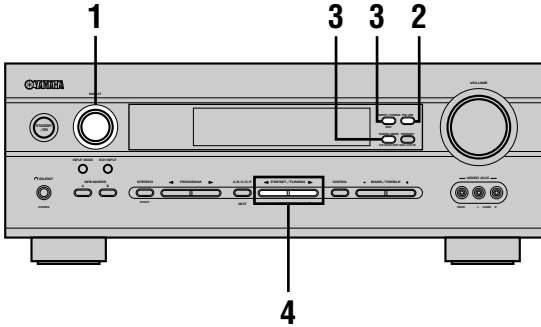

- 1 Rotate the INPUT selector (or press TUNER on the remote control) to select TUNER as the input source.

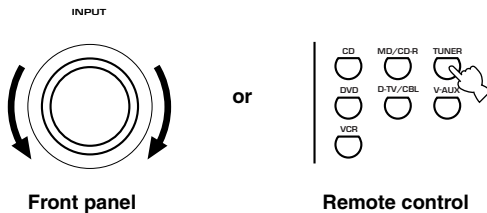

- 2 Press FM/AM to select the reception band. "FM" or "AM" appears on the front panel display.



- 3 Press TUNING MODE (AUTO/MAN'L MONO) so that the "AUTO" indicator lights up on the front panel display.



If the colon (:) appears on the front panel display, press PRESET/TUNING (EDIT) to turn it off.

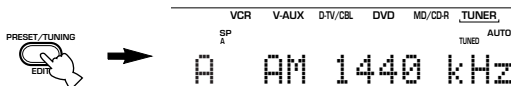

- 4 Press PRESET/TUNING </> once to begin automatic tuning.

Press > to tune in to a higher frequency, or press < to tune in to a lower frequency.

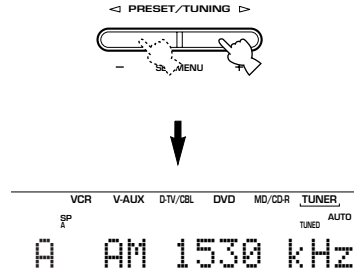

When the unit is tuned in to a station, the "TUNED" indicator lights up and the frequency of the station received is shown on the front panel display.

■ Manual tuning

If the signal from the station you are trying to select is weak, you must tune in to it manually.

- 1 Select TUNER and the reception band following steps 1 and 2 described in "Automatic tuning" at left.
- 2 Press TUNING MODE (AUTO/MAN'L MONO) until the "AUTO" indicator disappears from the front panel display.



If the colon (:) appears on the front panel display, press PRESET/TUNING (EDIT) to turn it off.

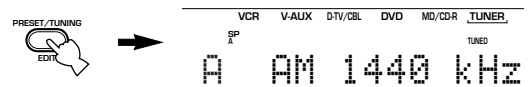

- 3 Press PRESET/TUNING </> to tune in to the desired station manually.

Hold down the button to continue searching.

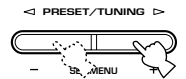

Note

- Manually tuning in to an FM station will automatically change the reception mode to monaural to increase the signal quality.

Presetting stations

Automatically presetting stations (for FM stations)

You can use the automatic preset tuning feature to store FM stations. This function enables the unit to automatically tune in to FM stations with strong signals, and to store up to 40 (8 stations x 5 groups) of those stations in order. You can then recall any preset station easily by selecting the preset number.

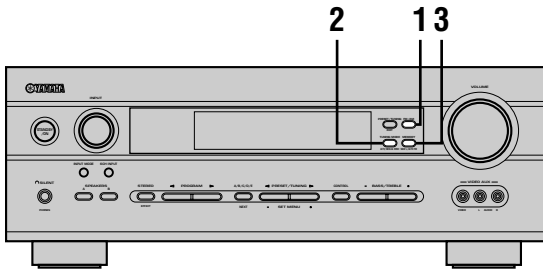

1 Press FM/AM to select the FM band.

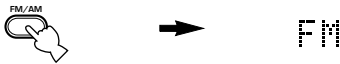

2 Press TUNING MODE (AUTO/MAN'L MONO) until the "AUTO" indicator lights up on the front panel display.



3 Press and hold MEMORY (MAN'L/AUTO FM) for at least 3 seconds.

The preset number and the "MEMORY" and "AUTO" indicators flash. After about 5 seconds, automatic preset tuning starts, beginning at the frequency currently displayed and moving toward the higher frequencies.

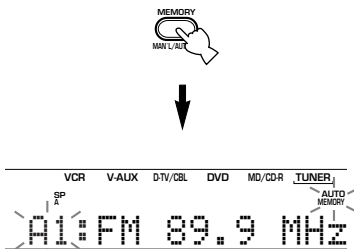

When automatic preset tuning is completed, the front panel display shows the frequency of the last preset station.

Notes

- Any stored station data existing under a preset number is cleared when you store a new station under that preset number.
- If the number of the received stations does not reach E8, automatic preset tuning has automatically stopped after searching all stations.
- Only FM stations with sufficient signal strength are stored automatically by automatic preset tuning. If the station you want to store is weak in signal strength, tune in to it manually in the monaural mode, and store it by following the procedure described in "Manually presetting stations".

Automatic preset tuning options

You can select the preset number from which this unit will store FM stations and/or begin tuning toward lower frequencies. After pressing MEMORY in step 3:

- Press A/B/C/D/E and PRESET/TUNING </> to select the preset number under which the first station will be stored. Automatic preset tuning will stop when stations have all been stored up to E8.
- Press PRESET/TUNING (EDIT) to turn off the colon (:), and then press PRESET/TUNING </> to begin tuning toward lower frequencies.

Memory back-up

The memory back-up circuit prevents the stored data from being lost even if this unit is set in standby mode, the power cord is disconnected from the AC outlet, or the power supply is temporarily cut due to power failure. However, if the power is cut for more than one week, the preset stations may be cleared. If so, store the stations again.

Manually presetting stations

You can store up to 40 stations (8 stations x 5 groups) manually.

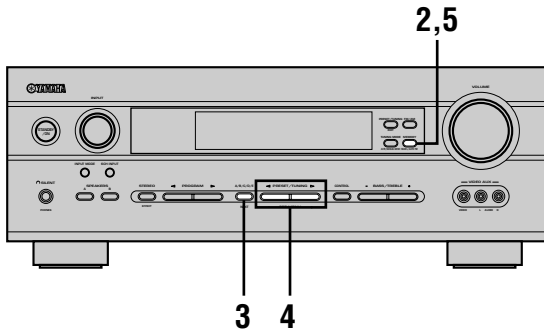

1 Tune in to a station.

See page 32 for tuning instructions.

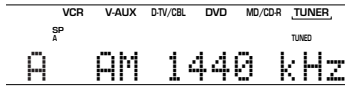

When tuned to a station, the front panel display shows the frequency of the station received.

2 Press MEMORY (MAN'L/AUTO FM).

The "MEMORY" indicator flashes for about 5 seconds.

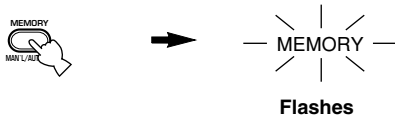

3 Press A/B/C/D/E repeatedly to select a preset station group (A to E) while the "MEMORY" indicator is flashing.

The group letter appears. Check that the colon (:) is showing on the front panel display.

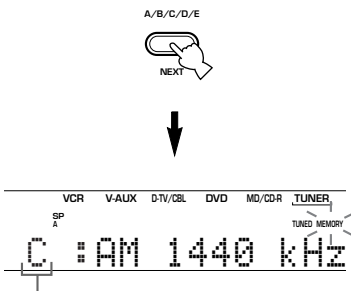

Preset group

4 Press PRESET/TUNING </> to select a preset station number (1 to 8) while the "MEMORY" indicator is flashing.

Press > to select a higher preset station number. Press < to select a lower preset station number.

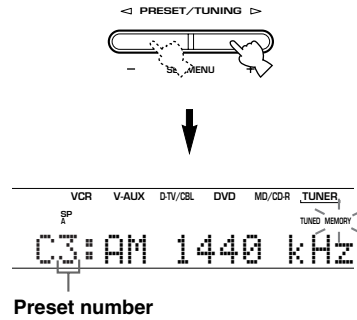

5 Press MEMORY (MAN'L/AUTO FM) on the front panel while the "MEMORY" indicator is flashing.

The station band and frequency appear on the front panel display with the preset group and number you have selected.

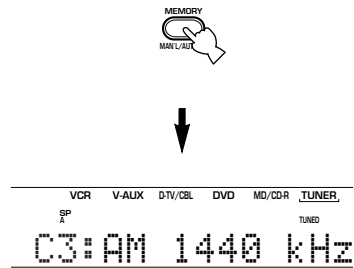

Shows the displayed station has been stored as C3.

6 Repeat steps 1 to 5 to store other stations.

Notes

- Any stored station data existing under a preset number is cleared when you store a new station under that preset number.
- The reception mode (stereo or monaural) is stored along with the station frequency.

Selecting a preset station

You can recall any desired station simply by selecting the preset station number under which it was stored.

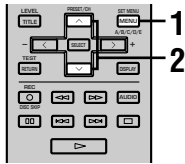
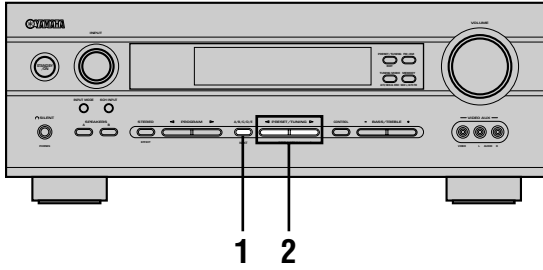

- 1 Press A/B/C/D/E (A/B/C/D/E on the remote control) to select the preset station group.** The preset group letter appears on the front panel display and changes each time you press A/B/C/D/E.



Front panel

or



Remote control

- 2 Press PRESET/TUNING </> (PRESET ^ / v on the remote control) to select a preset station number (1 to 8).**

The preset group and number appear on the front panel display along with the station band and frequency, and the "TUNED" indicator lights up.



Front panel

or

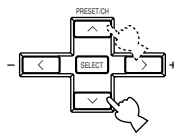

Remote control

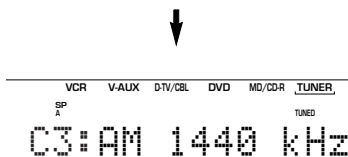

Exchanging preset stations

You can exchange the assignment of two preset stations. The example below describes the procedure for exchanging preset station "E1" with "A5".

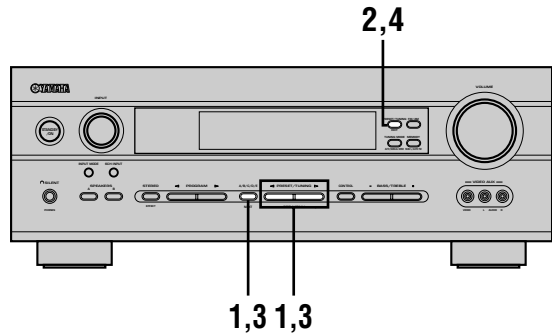

- 1 Select preset station "E1" by using the A/B/C/D/E and PRESET/TUNING </>.** See "Selecting a preset station" at left.
- 2 Press and hold PRESET/TUNING (EDIT) for at least 3 seconds.** "E1" and the "MEMORY" indicator flash on the front panel display.

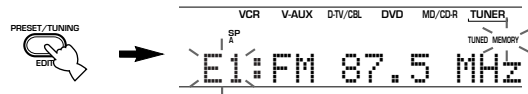

- 3 Select preset station "A5" by using the A/B/C/D/E and PRESET/TUNING </>.** "A5" and the "MEMORY" indicator flash on the front panel display.

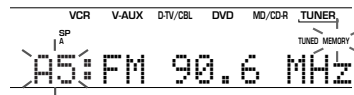

- 4 Press PRESET/TUNING (EDIT) again.** The stations stored at the two preset assignments are exchanged.

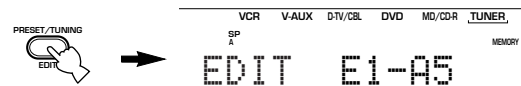

Shows the exchange of stations has been completed.

SLEEP TIMER

Use this feature to automatically set this unit in standby mode after the amount of time you have set. The sleep timer is useful when you are going to sleep while this unit is playing or recording a source. The sleep timer also automatically turns off the external component(s) connected to AC OUTLET(S).

The sleep timer can only be set with the remote control.



- By connecting a commercially available timer to this unit, you can also set a wake-up timer. Refer to the operation instructions of the timer.

Setting the sleep timer

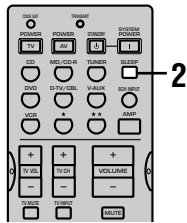

1 Select a source and start playback on the source component.

2 Press **SLEEP** repeatedly to set the amount of time.

Each time you press **SLEEP**, the front panel display changes as shown below.

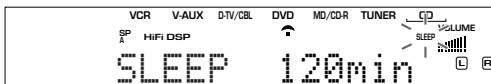
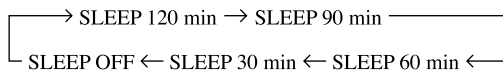

3 The “**SLEEP**” indicator lights up on the front panel display soon after the sleep timer has been set.

The display then returns to the previous indication.

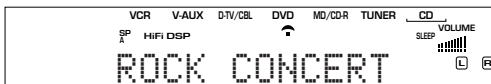

Canceling the sleep timer

Press **SLEEP** repeatedly until “**SLEEP OFF**” appears on the front panel display.

After a few seconds, “**SLEEP OFF**” disappears, the “**SLEEP**” indicator goes off and the display returns to the previous indication.

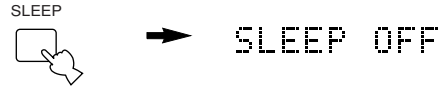

- The sleep timer setting can also be canceled by setting this unit in standby mode by using **STANDBY** on the remote control (or **STANDBY/ON** on the front panel) or by disconnecting the AC power cord from the AC outlet.

RECORDING

Recording adjustments and other operations are performed on other recording components. Refer to the operation instructions for these components for details on their operation.

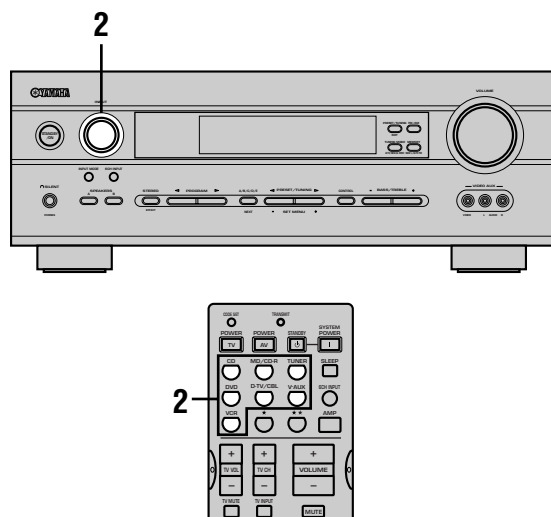

1 Turn on the power of this unit and all connected components.

2 Select the source component you want to record from.

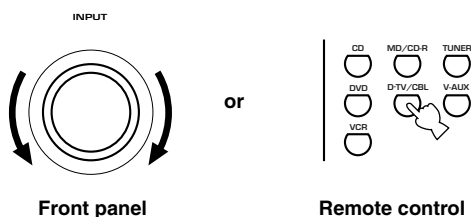

3 Start playback (or select a broadcast station) on the source component.

4 Start recording on the recording component.

Notes

- Do a test recording before you start an actual recording.
- When this unit is set in standby mode, you cannot record between the components connected to it.
- DSP programs and volume, bass, and treble settings do not affect the recorded material.
- You cannot record from a source connected to the 6CH INPUT jacks on this unit.
- Input sources are not output to the same OUT (REC) channel. (For example, the signal input from VCR IN is not output to VCR OUT.)
- This unit's DIGITAL OUTPUT jack and analog OUT(REC) jacks are independent. To record a source using a digital recording component connected to the DIGITAL OUTPUT jack, connect the source component to one of the DIGITAL INPUT jacks.
- Check the copyright laws in your country if you wish to record from records, CDs, radio, etc. Recording of copyrighted material may infringe copyright laws.

If you playback a video source that uses scrambled or encoded signals to prevent it from being dubbed, the picture itself may be disturbed due to those signals.

Special considerations when recording DTS material

The DTS signal is a digital bitstream. Attempting to digitally record the DTS bitstream will result in noise being recorded. Therefore, if you want to use this unit to record sources that have DTS signals recorded on them, the following considerations and adjustments need to be made.

For LDs, DVDs and CDs encoded with DTS, follow the operating instructions of your player to set it to output an analog signal, if it is compatible with the DTS format.

SET MENU

You can set the following parameters on the set menu to obtain a better sound from the unit. Change the settings to reflect the needs of your listening environment.

Set menu list

The set menus are divided by use and function into the 4 categories listed here.

■ BASIC

The BASIC area contains the basic parameters that you must set before using this unit. It consists of the following menus. See pages 19 – 21 for a detailed explanation.

1 SETUP

2 SP LEVEL (Speaker level)

■ SOUND

The SOUND area contains parameters for altering sound output. It consists of the following menus that you can use to alter the quality and tone of the sound output by the system.

1 SPEAKER SET

2 SP DISTANCE (Speaker distance)

3 LFE LEVEL (Low frequency effect level)

4 D. RANGE (Dynamic range)

5 CENTER GEQ (Center graphic equalizer)

6 HP TONE CTRL (Headphone tone control)

■ INPUT

The INPUT area contains parameters concerned with signal input. It consists of the following menus that you can use to change the assignment of input jacks.

1 I/O ASSIGN

2 INPUT MODE

■ OPTION

This is a supplementary set up menu provided for your convenience. It consists of the following menus that you can use to change display brightness, protect existing settings, and perform other non-essential functions.

1 DISPLAY SET

2 MEM. GUARD

3 AUDIO MUTE

4 ZONE SET

- In the descriptions for each item from the following page, the default setting is indicated in bold.

Adjusting the items on the set menu

Use the remote control to make adjustments.

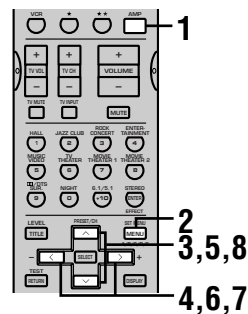

- You can change set menu parameters while the unit is reproducing sound.
- You can use NEXT and SET MENU +/- on the front panel to change these settings, if the unit is not set to TUNER mode. Press NEXT to select the category or field you wish to change, and SET MENU +/- to change the parameters.

Note

- You cannot change some set menu parameters while the unit is in night listening mode.

1 Press AMP.



2 Press SET MENU to enter the set menu.



3 Press ^ / ∨ repeatedly to select the desired menu.

4 Press < / > to enter the selected menu.

5 Press ^ / ∨ repeatedly to select the item you want to adjust.

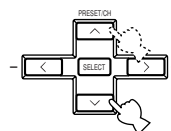

- By pressing SET MENU repeatedly, you can select items in the same order as when pressing ∨.

6 Press </> once to enter the setup mode of the selected item.

The last setting you adjusted appears on the front panel display.

Depending on the menu item, press ^/∨ to select a sub item.

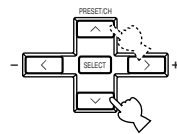
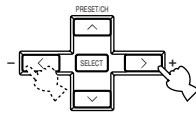

7 Press </> repeatedly to change the menu item setting.

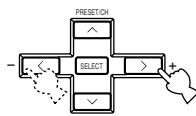

8 Press ^/∨ repeatedly until the menu disappears or just press one of the DSP program group buttons to exit from the set menu.

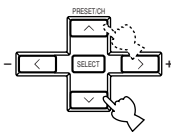

or

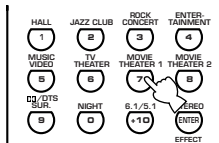

SOUND 1 SPEAKER SET (speaker mode settings)

Use this feature to select suitable output modes for your speaker configuration.

Note

- Some menu item settings have no effect when the unit is reproducing a source with a digital signal sampling frequency greater than 48 kHz.

■ 1A CENTER (center speaker mode)

If you add a center speaker to your speaker configuration, this unit can provide better dialog localization for several listeners and superior synchronization of sound and images.

Choices: LRG (large), SML (small), NON (none)

LRG

Select this if you have a large center speaker. The unit directs the entire range of the center channel signal to the center speaker.

SML

Select this if you have a small center speaker. The unit directs the low-frequency signals (90 Hz and below) of the center channel to the speakers selected with "1E BASS".

NON

Select this if you do not have a center speaker. The unit directs all of the center channel signal to the main left and right speakers.

Memory back-up

The memory back-up circuit prevents the stored data from being lost even if this unit is in standby mode. However, if the power cord is disconnected from the AC outlet, or the power supply is cut for more than one week, the stored data will be lost. If this happens, adjust the items again.

The BASIC and SOUND menus

The "BASIC" menu allows you to easily set the "SOUND 1 SPEAKER SET" and "SOUND 2 SP DISTANCE" parameters. It is not necessary to reset any of the parameters in the "BASIC" menu, but you can access more detailed parameters in the "SOUND" menu if you wish.

Note

- After altering parameters in the "SOUND" menu, if you select "BASIC 1 SETUP" and then select "SET", the parameters from the "SOUND" menu alter in response to any changes you make in "BASIC 1 SETUP". Do not enter the "BASIC 1 SETUP" menu unless you wish to change these settings. If you accidentally enter the "BASIC 1 SETUP" menu, select "CANCEL" to return to the "BASIC" menu. (page 20)

■ 1B MAIN (main speaker mode)

Choices: **LARGE**, **SMALL**

LARGE

Select this if you have large main speakers. The unit directs the entire range of the main left and right channel signals to the main left and right speakers.

SMALL

Select this if you have small main speakers. The unit directs the low-frequency signals (90 Hz and below) of the main channel to the speakers selected with "1E BASS".

■ 1C REAR LR (rear speaker mode)

Choices: **LRG** (large), **SML** (small), **NON** (none)

LRG

Select this if you have large rear left and right speakers or if a rear subwoofer is connected to the rear speakers. The entire range of the rear channel signal is directed to the rear left and right speakers.

SML

Select this if you have small rear left and right speakers. The low-frequency signals (90 Hz and below) of the rear channel are directed to the speakers selected with "1E BASS".

NON

Select this if you do not have rear speakers.



- This unit is set in the virtual CINEMA DSP mode when you select **NON** for "1C REAR LR". In this case, the rear center speaker will automatically be set to **NON** and the "1D REAR CT" item will be skipped.

■ 1D REAR CT (rear center speaker mode)

If you add a rear center speaker to your speaker configuration, this unit can provide more realistic front-to-back transitions.

Choices: **LRG** (large), **SML** (small), **NON** (none)

LRG

Select this if you have a large rear center speaker. The unit directs the entire range of the rear center channel signal to the rear center speaker.

SML

Select this if you have a small rear center speaker. The unit directs the low-frequency signals (90 Hz and below) of the rear center channel to the speakers selected with "1E BASS".

NON

Select this if you do not have a rear center speaker. The unit directs all of the rear center channel signal to the rear left and right speakers.

■ 1E BASS (bass out mode)

LFE signals carry low-frequency effects when this unit decodes a Dolby Digital or DTS signal. Low-frequency signals are defined as 90 Hz and below. The Low-frequency signals can be directed to both main left and right speakers, and to the subwoofer (subwoofer can be used for both stereo reproduction and the DSP program).

Choices: **SWFR** (subwoofer), **MAIN**, **BOTH**

SWFR

Select this if you use a subwoofer. The unit directs the LFE signals to the subwoofer.

MAIN

Select this if you do not use a subwoofer. The unit directs LFE signals to the main speakers.

BOTH

The unit directs LFE signals to the subwoofer. Low-frequency signals designated to the main channels in accordance with other speaker mode settings are directed to both main speakers and the subwoofer.

Note

- When you select **MAIN** for "1E BASS", the unit directs the low-frequency signals (90 Hz and below) of the main channel to the main speakers even if you select **SMALL** for the main speaker mode.

SOUND 2 SP DISTANCE (speaker distance)

Use this feature to adjust the delay applied to center and rear center channel sounds. This feature works when there is sound output from the center speakers with a source such as Dolby Digital or DTS. Ideally, the center speaker and the rear speakers should be the same distance from the main listening position as the left and right main speakers. However, in most home situations, the center speaker or the rear center speaker is placed in line with the main speakers or the rear speakers. By delaying the sound from the center speaker and the rear speakers, you can adjust the apparent distance from the center speaker and the rear speakers to the main listening position to make it seem the same as the distance between the listening position and main left and right speakers.

- 1** Press \wedge / \vee to select "UNIT".
- 2** Press \langle / \rangle to select the unit "meters" or "feet" to be used in setting.
- 3** Press \wedge / \vee to select the speaker for which you want to adjust the delay.
- 4** Press \langle / \rangle to set the delay.
Press \rangle for higher values and \langle for lower values.

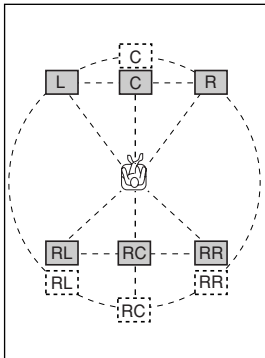

■ Setting by "meters"

Control range: 0.3 to 24.00 m (for main L/R, center, rear L/R, rear center)
Initial settings: 3.00 m (for main L/R, center, rear L/R), 2.10 m (for rear center)

■ Setting by "feet"

Control range: 1 to 80 ft (for main L/R, center, rear L/R, rear center)
Initial settings: 10.0 ft (for main L/R, center, rear L/R), 7.0 ft (for rear center)

Note

- No delay will be set if you set the same distance for the main L/R and center, or the rear L/R and rear center.

SOUND 3 LFE LEVEL

Use this feature to adjust the output level of the LFE (low-frequency effect) channel when playing back a Dolby Digital or DTS signal. The LFE signal carries low-frequency special effect sound which is only added to certain scenes.

Control range:
SPEAKER -20 to 0 dB
HEADPHONE -20 to 0 dB
Initial setting: 0 dB

- 1** Press \wedge / \vee to select the item to be adjusted.

- 2** Press \langle to adjust the LFE level.

Note

- Adjust the LFE level according to the capacity of your subwoofer or headphones.

SOUND 4 D. RANGE (dynamic range)

Use this feature to adjust the dynamic range. This setting is effective only when the unit is decoding Dolby Digital signals.

Choices: **MAX**, STD (standard), MIN (minimum)

MAX

Select MAX for feature films.

STD

Select STD for general use.

MIN

Select MIN for listening to sources at low volume levels.

SOUND 5 CENTER GEQ (center graphic equalizer)

Use this feature to adjust the built-in 5-band graphic equalizer so that the center speaker tonal quality matches that of the left and right main speakers. You can select the 100 Hz, 300 Hz, 1 kHz, 3 kHz, or 10 kHz frequencies. Control range (dB): -6 to +6
Initial setting: 0 dB for 5-band

1 Press \vee to select a higher frequency and \wedge to select a lower frequency.

2 Press \langle / \rangle to adjust the level of that frequency.

Note

- You can monitor the center speaker sound while adjusting this parameter by using the test tone. Press TEST before starting the foregoing procedure. Once you begin this procedure, the test tone remains at the center speaker and you can hear how the sound changes as you adjust the various frequency levels. To stop the test tone, press TEST.

SOUND 6 HP TONE CTRL (headphone tone control)

Use this feature to adjust the level of the bass and treble when you are using headphones.

Control range (dB):

BASS -6 to +3
TRBL (treble) -6 to +3

Initial setting:

BASS 0 dB
TRBL 0 dB

INPUT 1 I/O ASSIGN (input/output assignment)

You can assign jacks according to the component to be used if this unit's COMPONENT VIDEO input jack or DIGITAL INPUT/OUTPUT jack settings (component names for jacks) differ from those of the component. This lets you to change the jack assignment and effectively connect more components.

Once assigned, select that component with INPUT (or the input selector buttons on the remote control).

■ 1A for COMPONENT VIDEO INPUT jacks

Choices: [A] DVD, VCR, V-AUX, D-TV/CBL
[B] DVD, VCR, V-AUX, **D-TV/CBL**

■ 1B for OPTICAL OUTPUT jack

RX-V540

Choices: (1) MD/CD-R, CD, VCR, V-AUX, D-TV/CBL, DVD

■ 1C for OPTICAL INPUT jacks

RX-V540

Choices: (2) MD/CD-R, CD, VCR, V-AUX, D-TV/CBL, DVD
(3) MD/CD-R, CD, VCR, V-AUX, D-TV/CBL, **DVD**
(4) MD/CD-R, CD, VCR, V-AUX, **D-TV/CBL**, DVD

RX-V440

Choices: (1) MD/CD-R, CD, VCR, V-AUX, D-TV/CBL, **DVD**

■ 1D for COAXIAL INPUT jack

RX-V540

Choices: (5) MD/CD-R, **CD**, VCR, V-AUX, D-TV/CBL, DVD

RX-V440

Choices: (2) MD/CD-R, **CD**, VCR, V-AUX, D-TV/CBL, DVD

Notes

- You cannot select a specific item more than once for the same type of jack.
- When you connect a component to both the COAXIAL and OPTICAL jacks, priority is given to the input signals from the COAXIAL jack.

INPUT 2 INPUT MODE (initial input mode)

Use this feature to designate the input mode for sources connected to the DIGITAL INPUT jacks when you turn this unit on (see page 24 for details about the input mode).

Choices: **AUTO**, **LAST**

AUTO

Select this setting to allow the unit to automatically detect the type of input signal and select the appropriate input mode.

LAST

Select this setting to set this unit to automatically select the last input mode used for the respective sources.

OPTION 1 DISPLAY SET

■ **DIMMER**

Use this to adjust the brightness of the front panel display.

Control range: -4 to **0**

■ **V CONV. (Video conversion)** RX-V540

(With the exception of China and General models)

Use this feature to turn on/off the conversion of composite signals to S-video signals to output through the S-video jack when the unit is receiving a video signal that is not in the S-video format.

Choices: **ON**, **OFF**

ON

Select **ON** to convert composite signals to S-video signals.

OFF

Select **OFF** to stop the conversion of composite signals to S-video signals.

OPTION 2 MEM. GUARD (memory guard)

Use this feature to prevent accidental changes to settings on the unit.

Choices: **ON**, **OFF**

Select **ON** to protect the following features:

- All set menu items
- Center, rear speakers, rear center, and subwoofer levels
- DSP program parameters

Notes

- When this item is set to **ON**, you cannot use the test tone.
- When this item is set to **ON**, you cannot select any other set menu items.

OPTION 3 AUDIO MUTE

Adjusts the amount by which the **MUTE** function reduces the output volume.

Choices: **MUTE**, -50dB, -20dB

MUTE

Completely halts all output of sound.

-50dB

Reduces the volume of the present sound output by 50dB.

-20dB

Reduces the volume of the present sound output by 20dB.

OPTION 4 ZONE SET

■ SP B (speaker B set)

Use this feature to select the location of the main speakers connected to the SPEAKERS B terminals.

Choices: **MAIN**, ZONE B

MAIN

Select this to turn on/off SPEAKERS A and B when the speakers connected to the SPEAKERS B terminals are set in the main room.

ZONE B

Select this if the speakers connected to the SPEAKERS B terminals are set another room. If SPEAKERS A is turned OFF and SPEAKERS B is turned ON, all the speakers including the subwoofer in the main room are muted and the unit outputs sound from SPEAKERS B only.

Notes

- If you connect headphones to the PHONES jack on the unit, the sound is output from both headphones and SPEAKERS B.
- When a DSP program is selected, the unit automatically enters the Virtual CINEMA DSP mode.

REMOTE CONTROL FEATURES

In addition to controlling this unit, the remote control can operate other A/V components made by YAMAHA and other manufacturers. To control other components, set up the remote control with the appropriate manufacturer codes.

Control area

■ Controlling this unit

The shaded areas below can be used to control this unit when the AMP mode is selected. Press AMP to select the AMP mode.

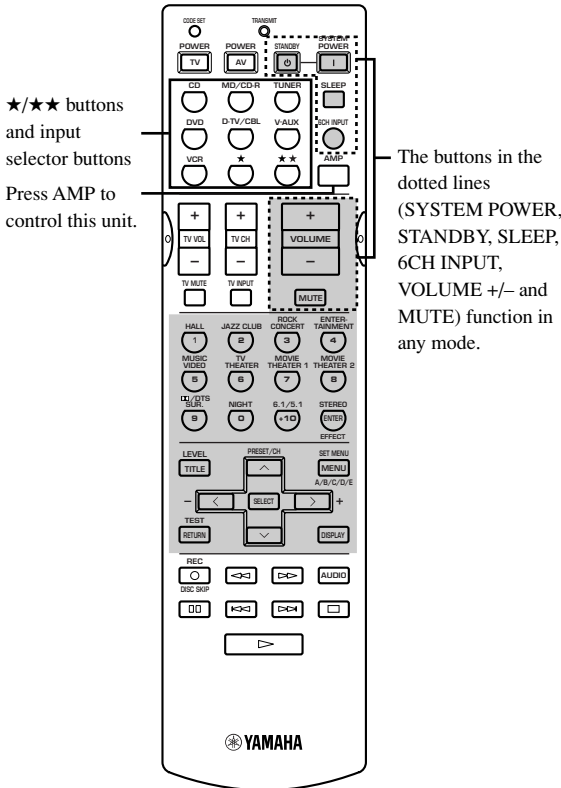

■ Controlling other component

The shaded areas below can be used to control other components. Each button has a different function depending on the selected components. Select the component you want to control by pressing an input selector button.

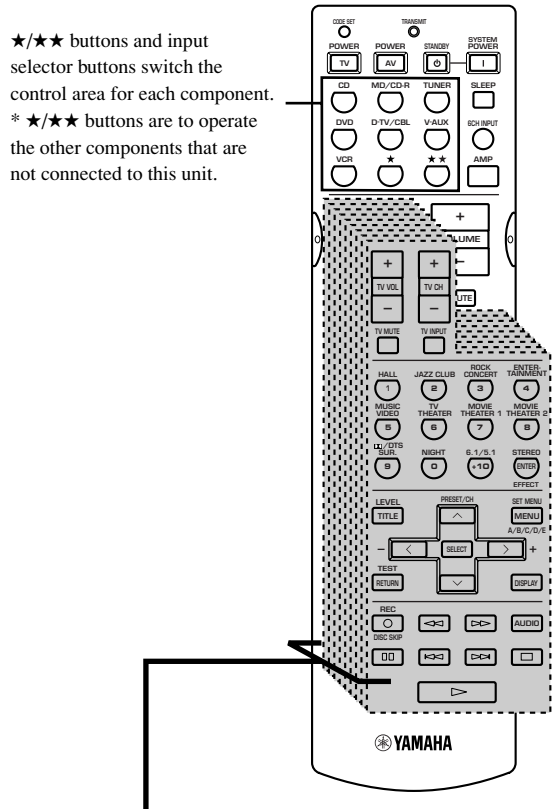

Component control area

You can control up to 9 different components by setting appropriate manufacturer codes (see page 47).

ADVANCED
OPERATION

English

Setting the manufacturer code

You can control other components by setting a manufacturer code. Codes can be set for each of the 9 component controls.

The following table shows factory-set component (Library: component category) and the manufacturer code for each component control.

Component control (buttons)	Component category (Library)	Manufacturer	Code
CD	CD	YAMAHA	0005
MD/CD-R	MD	YAMAHA	0024
TUNER	TUNER	YAMAHA	0003
DVD	DVD	YAMAHA	0098
D-TV/CBL	-	-	-
V-AUX	-	-	-
VCR	-	-	-
★	-	-	-
★★	-	-	-

1 Press an input selector button or ★/★★ to select the component you want to set up.

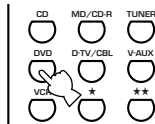

2 Press CODE SET using a ballpoint pen or similar object.

The TRANSMIT indicator flashes twice.



3 Press the numeric buttons to enter the four digit manufacturer's code for the component to be used.

Refer to "LIST OF MANUFACTURER'S CODES" at the end of this manual.

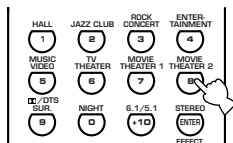

The TRANSMIT indicator flashes twice.

Notes

- If the manufacturer of your component has more than one code, try each of them until you find the correct one.
- If you wait for more than 30 seconds during step 3, the setup process is canceled. If this happens, start over from step 2.

Clearing setup manufacturer codes

■ Clearing setup manufacturer code for the component control

1 Press an input selector button or ★/★★ to select the component control for which you want to clear the manufacturer code.

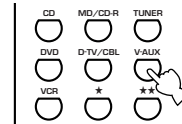

2 Press CODE SET by using a ballpoint pen or similar object.

The TRANSMIT indicator flashes twice.



Note

- If you do not press any button within 30 seconds after step 2, the clearing process cancels. If this happens, start over from step 1.

3 Enter the code number "0000".

The TRANSMIT indicator flashes twice, and the manufacturer code for the selected component is cleared.



- You can clear all setup manufacturer codes at once by entering the code number "9990".

Controlling other components

You can operate other components if you have set the manufacturer code for your component in the remote control. Note, however, that some buttons may not operate the component correctly.

Once you select an input source, the remote control switches to the mode for operating the component.

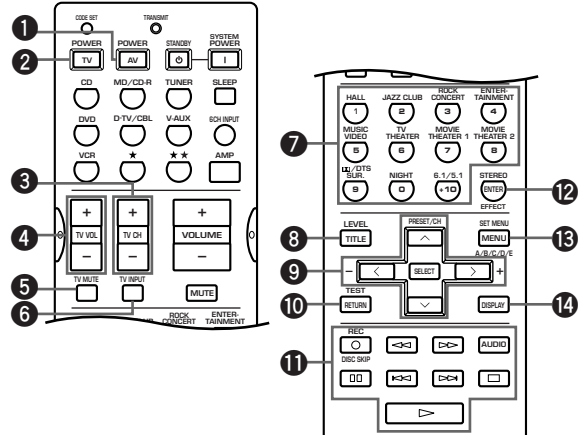

	DVD player	VCR	TV, digital/cable TV	CD player	CD/MD recorder	Tuner
1 AV POWER	* ¹ Power	* ¹ Power	* ³ VCR power	* ¹ Power	* ¹ Power	* ¹ Power
2 TV POWER	* ² TV power	* ² TV power	* ² TV power	* ² TV power	* ² TV power	* ² TV power
3 TV CH +	* ² TV channel up	* ² TV channel up	TV channel up	* ² TV channel up	* ² TV channel up	* ² TV channel up
TV CH -	* ² TV channel down	* ² TV channel down	TV channel down	* ² TV channel down	* ² TV channel down	* ² TV channel down
4 TV VOL +	* ² TV volume up	* ² TV volume up	TV volume up	* ² TV volume up	* ² TV volume up	* ² TV volume up
TV VOL -	* ² TV volume down	* ² TV volume down	TV volume down	* ² TV volume down	* ² TV volume down	* ² TV volume down
5 TV MUTE	* ² TV mute	* ² TV mute	TV mute	* ² TV mute	* ² TV mute	* ² TV mute
6 TV INPUT	* ² TV input	* ² TV input	TV input	* ² TV input	* ² TV input	* ² TV input
7 1-9, 0, +10	Numeric buttons	Numeric buttons	Numeric buttons	Numeric buttons	Numeric buttons	Preset stations (1-8)
8 TITLE	Title					
9 PRESET/CH ^	Up	VCR channel up				Preset up
PRESET/CH v	Down	VCR channel down				Preset down
PRESET/CH <	Left					
PRESET/CH >	Right					
SELECT	Select					
10 RETURN	Return					
11 REC/DISC SKIP	Disc skip	Rec	* ³ VCR rec	Disc skip	Rec (MD)	
▷	Play	Play	* ³ VCR play	Play	Play	
◀◀	Search backward	Search backward	* ³ VCR search backward	Search backward	Search backward	
▶▶	Search forward	Search forward	* ³ VCR search forward	Search forward	Search forward	
AUDIO	Audio					
⏸	Pause	Pause	* ³ VCR pause	Pause	Pause	
◀◀	Skip backward			Skip backward	Skip backward	
▶▶	Skip forward			Skip forward	Skip forward	
□	Stop	Stop	* ³ VCR stop	Stop	Stop	
12 ENTER	Title/Index	Enter	Enter	Index	Index	
13 MENU	Menu					A/B/C/D/E
14 DISPLAY	Display			Display	Display	

*¹ This button functions only when the original remote control of the component has a POWER button.

*² These buttons can operate your TV without switching the input if the manufacturer code is set in D-TV/CBL or ★★. When the manufacturer code for your TV is set up in the both D-TV/CBL and ★★ areas, priority is given to the signal in the D-TV/CBL area.

*³ These buttons can operate your VCR without switching the input to VCR if the manufacturer code is set in VCR.

SETTING THE SPEAKER LEVELS

Adjusting the volume during playback

You can adjust the volume of the speakers while listening to sound playback.

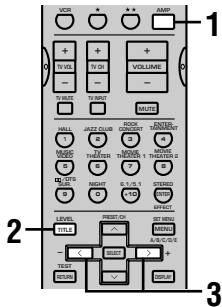

1 Press AMP.

2 Press LEVEL repeatedly to select the speaker you want to adjust.

The unit cycles through the speakers in the following order each time you press LEVEL:
 MAIN L→CENTER→MAIN R→R SUR.
 (rear R)→REAR CT (rear center)→L SUR.
 (rear L)→SWFR (subwoofer)→.....



- Pressing LEVEL once opens the level display. Press \wedge / \vee at this time to select a speaker.

3 Press \langle / \rangle to adjust the speaker volume.

- The center and rear speakers can be adjusted by a maximum of $-10\text{dB} \sim +10\text{dB}$.
- The main speakers and subwoofer can be adjusted by a maximum of $-20\text{dB} \sim 0\text{dB}$.

Notes

- You cannot adjust speaker levels if the “SOUND 1 SPEAKER SET” parameter in the set menu is set to NON.
- You cannot adjust the subwoofer level if the “1E BASS” parameter in “SOUND 1 SPEAKER SET” in the set menu is set to MAIN.
- If you use LEVEL to adjust speaker levels, the speaker levels you previously set with the test tone will also change.
- If you select “BASIC 1 SETUP” in the set menu and then select “SET”, speaker levels change in response to any changes you make in “BASIC 1 SETUP”.

Using the test tone

Use the test tone to set speaker levels so that the volume from each speaker is identical when heard from your listening position.

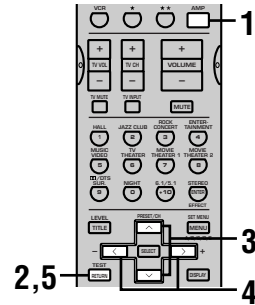

1 Press AMP.

2 Press TEST.

The unit will output a test tone.

3 Press \wedge / \vee repeatedly to select a speaker to adjust.

Each time you press \vee , the unit will cycle through the speakers in the following order:

TEST LEFT(main L)→TEST CENTER(center)→TEST RIGHT(main R)→TEST R SUR.(rear R)→TEST REAR CNTR(rear center)→TEST L SUR.(rear L)→TEST SUBWOOFER(subwoofer)→.....
 (Press \wedge to cycle the speakers in the reverse order.)

4 Press \langle / \rangle to adjust speaker volumes.

5 Press TEST when you have completed your adjustment.

The test tone halts.

Notes

- You cannot enter test mode if headphones are connected to the PHONES jack. Remove the headphones from the PHONES jack.
- You cannot adjust speaker volumes if the “SOUND 1 SPEAKER SET” parameter on the set menu is set to NON.
- You cannot adjust the subwoofer level if the “1E BASS” parameter in “SOUND 1 SPEAKER SET” in the set menu is set to MAIN.
- If you select “BASIC 1 SETUP” in the set menu and then select “SET”, speaker levels change in response to any changes you make in “BASIC 1 SETUP”.



- Depending on the source the unit is reproducing, the speaker levels set with the test tone may not be to your liking. If this is the case, adjust the speaker levels while listening to the source.

SOUND FIELD PROGRAM PARAMETER EDITING

Changing parameter settings

The initial sound field program settings will provide you an excellent listening experience as they are. It is not necessary to alter these settings, but you can create an original listening environment by doing so.

Note

- The editable parameters vary depending on the sound field program you select. Refer to the explanation for the parameter.

- Repeat steps 2 – 4 if you wish to alter other parameters.

Note

- You cannot alter these parameters if the “OPTION 2 MEM. GUARD” parameter in the set menu is set to ON. Change this setting to OFF if you wish to alter any other parameters.

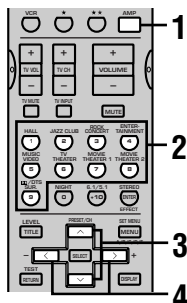

- Press AMP.



- Select a sound field program.

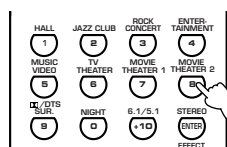

- Press ^ / v to select the parameter you want to change.

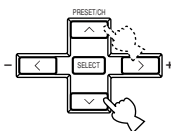

- Press < / > to change the parameter setting.

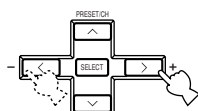

Digital sound field parameter descriptions

You can adjust the values of certain digital sound field parameters so the sound fields are recreated accurately in your listening room. Not all of the following parameters are found in every program.

■ DSP LEVEL

Function: This parameter adjusts the level of all the DSP effect sounds within a narrow range.

Description: Depending on the acoustics of your listening room, you may want to increase or decrease the DSP effect level relative to the direct sound.

Control Range: -6 dB to +3 dB

■ DELAY

Function: Adjusts the time difference between the beginning of the sound from the main speakers and the beginning of the sound effect from the rear speakers. The larger the value, the later the sound effect is generated.

Control range: 1 to 99 ms (Control range varies depending on the input source and the DSP program you use.)

For 6ch Stereo

Function: These parameters adjust the volume level for each channel in 6-channel stereo mode.

Control range: 0 to 100%

■ CT LEVEL (Center level)

■ RL LEVEL (Rear left level)

■ RR LEVEL (Rear right level)

■ RC LEVEL (Rear center level)

For PRO LOGIC II Music

■ PANORAMA

Function: Extends the front stereo image to include the surround speakers for a wraparound effect.

Choices: OFF/ON, initial setting is OFF.

■ DIMENSION

Function: Gradually adjusts the soundfield either towards the front or towards the rear.

Control range: -3 (towards the rear) to +3 (towards the front), initial setting is STD (standard).

■ CT WIDTH (Center width)

Function: Adjusts the center image from all three front speakers to varying degrees. A larger value adjusts the center image towards the main left and right speakers.

Control range: 0 (center channel sound is output only from center speaker) to 7 (center channel sound is output only from main left and right speakers), initial setting is 3.

For DTS Neo:6 Music

■ C. IMAGE (Center Image)

Function: This parameter adjusts the center image from all three front speakers to varying degrees.

Control Range: 0 to 0.5

TROUBLESHOOTING

Refer to the chart below when this unit does not function properly. If the problem you are experiencing is not listed below or if the instruction below does not help, set this unit to standby mode, disconnect the power cord, and contact the nearest authorized YAMAHA dealer or service center.

■ General

Problem	Cause	Remedy	Refer to page
This unit fails to turn on when STANDBY/ON (or SYSTEM POWER) is pressed, or enters in standby mode soon after the power has been turned on.	The power cord is not connected or the plug is not completely inserted.	Connect the power cord firmly.	–
	The IMPEDANCE SELECTOR switch on the rear panel is not fully set to either the left or right position.	Set the switch fully to the left or right position when this unit is in standby mode.	16
	The protection circuitry has been activated.	Make sure all speaker wire connections on this unit and on all speakers are secure and that the wire for each connection is not touching anything other than its respective connection.	16 – 17
	This unit has been exposed to a strong external electric shock (such as lightning and strong static electricity).	Set this unit in standby mode, disconnect the power cord, plug it back in after 30 seconds, then use it normally.	–
No sound.	Incorrect input or output cable connections.	Connect the cables properly. If the problem persists, the cables may be defective.	10 – 17
	No appropriate input source is selected.	Select an appropriate input source with INPUT or 6CH INPUT (or the input selector buttons).	22
	The speaker connections are not secure.	Secure the connections.	16 – 17
	The main speakers have not been selected properly.	Select the main speakers with SPEAKERS A and/or B.	22
	The volume is turned down.	Turn up the volume.	23
	The sound is muted.	Press MUTE or any operation buttons on the unit to cancel mute and adjust the volume.	–
	Digital signals which this unit cannot reproduce are being received from a source component e.g. a CD-ROM.	Play a source whose signals this unit can reproduce.	–
The picture does not appear.	The output and input for the picture are connected to different types of video jacks.	Connect components using the same type of video jacks (S VIDEO, VIDEO (composite), or COMPONENT VIDEO) for both the input and output.	10 – 11
The sound suddenly goes off.	The protection circuit has been activated because of a short circuit, etc.	Check the IMPEDANCE SELECTOR switch is set to the appropriate position and then turn the unit back on.	16
		Check the speaker wires are not touching each other and then turn the unit back on.	–
	The sleep timer has turned the unit off.	Turn on the power, and play the source again.	–
	The sound is muted.	Press MUTE or any operation buttons on the unit to cancel a mute and adjust the volume.	–

Problem	Cause	Remedy	Refer to page
Only the speaker on one side can be heard.	Incorrect cable connections.	Connect the cables properly. If the problem persists, the cables may be defective.	16
No sound from the effect speakers.	The sound effect is switched off.	Press STEREO/EFFECT to turn it on.	–
	A Dolby Surround, Dolby Digital or DTS decoding DSP program is being used with material not encoded with Dolby Surround, Dolby Digital or DTS.	Select another DSP program.	25 – 30
	A digital signal with a sampling frequency greater than 48 kHz is input to this unit.		–
No sound from the center speaker.	The output level of the center speaker is set to minimum.	Raise the level of the center speaker.	48
	“SOUND 1A CENTER” on the set menu is set to NON.	Select the appropriate mode for your center speaker.	39
	One of the Hi-Fi DSP programs (1 to 4) has been selected (except for 6ch Stereo).	Select another DSP program.	25 – 30
	The source encoded with a Dolby Digital or DTS signal does not have a center channel signal.		–
No sound from the rear speakers.	The output level of the rear speakers is set to minimum.	Raise the output level of the rear speakers.	48
	A monaural source is being played with program 9.	Select another DSP program.	25 – 30
No sound from the subwoofer.	“SOUND 1E BASS” on the set menu is set to MAIN when a Dolby Digital or DTS signal is being played.	Select SWFR or BOTH.	40
	“SOUND 1E BASS” on the set menu is set to SWFR or MAIN when a 2-channel source is being played.	Select BOTH.	40
	The source does not contain low bass signals (90 Hz and below).		–
Poor bass reproduction.	“SOUND 1E BASS” on the set menu is set to SWFR or BOTH and your system does not include a subwoofer.	Select MAIN.	40
	The speaker mode settings (main, center, rear, or rear center) on the set menu does not match your speaker configuration.	Select the appropriate position for each speaker based on the size of the speakers in your configuration.	39 – 40

Problem	Cause	Remedy	Refer to page
No sound from the rear center speaker.	“SOUND 1C REAR LR” or “SOUND 1D REAR CT” on the set menu is set to NON.	Select LRG or SML.	40
	The Dolby Digital EX or the DTS-ES decoder is not switched on.	Press 6.1/5.1 on the remote control to switch the decoder on.	–
A “humming” sound can be heard.	Incorrect cable connections.	Firmly connect the audio plugs. If the problem persists, the cables may be defective.	–
The volume level cannot be increased, or the sound is distorted.	The component connected to the OUT (REC) jacks of this unit is turned off.	Turn on the power to the component.	–
The sound effect cannot be recorded.	It is not possible to record the sound effect with a recording component.		–
RX-V540 A source cannot be recorded by a digital recording component connected to the DIGITAL OUTPUT jack of this unit.	There is no source component connected to the DIGITAL INPUT jacks of this unit.	Connect the source component to the DIGITAL INPUT jacks of this unit.	10 – 12
The sound field parameters and some other settings on the unit cannot be changed.	“OPTION 2 MEM. GUARD” in the set menu is set to ON.	Set “OPTION 2 MEM. GUARD” in the set menu to OFF.	–
The unit does not operate properly.	The internal microcomputer has been frozen by an external electric shock (such as lightning or excessive static electricity) or by a power supply with low voltage.	Disconnect the AC power cord from the outlet and then plug it in again after about 30 seconds.	–
“CHECK SP WIRES” appears on the front panel display.	The speaker cables are short circuited.	Make sure all speaker cables are connected correctly.	–
There is noise interference from digital or high-frequency equipment, or this unit.	This unit is too close to the digital or high-frequency equipment.	Move this unit further away from such equipment.	–
The unit suddenly turns into standby mode.	The internal temperature has become too high and the overheat protection circuitry has been activated.	Wait until the unit cools down and then turn it back on.	–

■ **Tuner**

Problem		Cause	Remedy	Refer to page
FM	FM stereo reception is noisy.	The characteristics of FM stereo broadcasts may cause this problem when the transmitter is too far away or the antenna input is poor.	Check the antenna connections. Try using a high-quality directional FM antenna.	13
			Use the manual tuning method.	32
	There is distortion, and clear reception cannot be obtained even with a good FM antenna.	There is multipath interference.	Adjust the antenna position to eliminate multipath interference.	–
	The desired station cannot be tuned in with the automatic tuning method.	The station is too weak.	Use a high-quality directional FM antenna.	–
			Use the manual tuning method.	32
Previously preset stations can no longer be tuned in.	The unit has been disconnected for a long period.	Re-store the stations.	33	
AM	The desired station cannot be tuned in with the automatic tuning method.	The signal is weak or the antenna connections are loose.	Tighten the AM loop antenna connections and orient it for best reception.	–
			Use the manual tuning method.	32
	There are continuous crackling and hissing noises.	Noises result from lightning, fluorescent lamps, motors, thermostats and other electrical equipment.	Use an outdoor antenna and a ground wire. This will help somewhat, but it is difficult to eliminate all noise.	13
	There are buzzing and whining noises (especially in the evening).	A TV set is being used nearby.	Move this unit away from the TV.	–

■ **Remote control**

Problem	Cause	Remedy	Refer to page
The remote control does not work nor function properly.	Wrong distance or angle.	The remote control will function within a maximum range of 6 m (20 feet) and no more than 30 degrees off-axis from the front panel.	7
	Direct sunlight or lighting (from an inverter type of fluorescent lamp, etc.) is striking the remote control sensor of this unit.	Reposition this unit.	–
	The batteries are weak.	Replace all batteries with new ones.	3
	The manufacture code has not correctly set.	Set the code correctly.	46
		Try setting another code of the same manufacturer.	46
Even if the manufacturer code is correctly set, there are some models that do not respond to the remote control.			–

GLOSSARY

■ Dolby Surround

Dolby Surround uses a 4 channel analog recording system to reproduce realistic and dynamic sound effects: 2 main left and right channels (stereo), a center channel for dialog (monaural), and a rear channel for special sound effects (monaural). The rear channel reproduces sound within a narrow frequency range.

Dolby Surround is widely used with nearly all video tapes and laser discs, and in many TV and cable broadcasts as well. The Dolby Pro Logic decoder built into this unit employs a digital signal processing system that automatically stabilizes the volume on each channel to enhance moving sound effects and directionality.

■ Dolby Digital

Dolby Digital is a digital surround sound system that gives you completely independent multi-channel audio. With 3 front channels (left, center, and right), and 2 rear stereo channels, Dolby Digital provides 5 full-range audio channels. With an additional channel especially for bass effects, called LFE (low frequency effect), the system has a total of 5.1 channels (LFE is counted as 0.1 channel). By using 2-channel stereo for the rear speakers, more accurate moving sound effects and surround sound environment are possible than with Dolby Surround. The wide dynamic range (from maximum to minimum volume) reproduced by the 5 full-range channels and the precise sound orientation generated using digital sound processing provide listeners with previously unheard of excitement and realism.

With this unit, any sound environment from monaural up to a 5.1-channel configuration can be freely selected for your enjoyment.

Dolby Digital EX creates 6 full-bandwidth output channels from 5.1-channel sources. This is done using a matrix decoder that derives 3 surround channels from the 2 in the original recording. For the best results, Dolby Digital EX should be used with movie sound tracks recorded with Dolby Digital Surround EX. With this additional channel, you can experience more dynamic and realistic moving sound especially with scenes with “fly-over” and “fly-around” effects.

■ Dolby Pro Logic II

Dolby Pro Logic II is an improved technique used to decode vast numbers of existing Dolby Surround software. This new technology enables a discrete 5-channel playback with 2 main left and right channels, 1 center channel, and 2 rear left and right channels (instead of only 1 rear channel for conventional Pro Logic technology). A music mode is also available for 2-channel sources in addition to the movie mode.

■ DTS (Digital Theater Systems) Digital Surround

DTS digital surround was developed to replace the analog soundtracks of movies with a 6-channel digital sound track, and is now rapidly gaining popularity in movie theaters around the world. Digital Theater Systems Inc. has developed a home theater system so that you can enjoy the depth of sound and natural spatial representation of DTS digital surround in your home. This system produces practically distortion-free 6-channel sound (technically, a left, right and center channels, 2 rear channels, plus an LFE 0.1 channel as a subwoofer, for a total of 5.1 channels).

The unit incorporates DTS-ES decoder that enables 6.1-channel reproduction by adding the rear center channel to existing 5.1-channel format.

■ Neo:6

Neo:6 decodes the conventional 2-channel sources for 6 channel playback by a specific decoder. It enables playback with the full-range of channels with higher separation just like digital discrete signal playback. Two modes are available; “Music mode” for playing music sources and “Cinema mode” for movies.

■ LFE 0.1 channel

This channel is for the reproduction of low bass signals. The frequency range for this channel is 20 Hz to 120 Hz. This channel is counted as 0.1 because it only enforces a low frequency range compared to the full-range reproduced by the other 5 channels in a Dolby Digital or DTS 5.1 channel systems.

■ CINEMA DSP

Since the Dolby Surround and DTS systems were originally designed for use in movie theaters, their effect is best felt in a theater having many speakers and designed for acoustic effects. Since home conditions, such as room size, wall material, number of speakers, and so on, can differ so widely, it's inevitable that there are differences in the sound heard as well. Based on a wealth of actually measured data, YAMAHA CINEMA DSP uses YAMAHA original sound field technology to combine Dolby Pro Logic, Dolby Digital and DTS systems to provide the visual and audio experience of movie theater in the listening room of your own home.

■ SILENT CINEMA

YAMAHA has developed a natural, realistic sound effect DSP algorithm for headphones. Parameters for headphones have been set for each sound field so that accurate representations of all the sound field programs can be enjoyed using headphones.

■ Virtual CINEMA DSP

YAMAHA has developed a virtual CINEMA DSP algorithm that allows you to enjoy DSP sound field surround effects even without any rear speakers by using virtual rear speakers.

It is even possible to enjoy virtual CINEMA DSP using a minimal 2-speaker system that does not include a center speaker.

■ PCM (Linear PCM)

Linear PCM is a signal format under which an analog audio signal is digitized, recorded and transmitted without using any compression. This is used as a method of recording CDs and DVD audio. The PCM system uses a technique for sampling the size of the analog signal per very small unit of time. Standing for “pulse code modulation”, the analog signal is encoded as pulses and then modulated for recording.

■ Sampling frequency and number of quantized bits

When digitizing an analog audio signal, the number of times the signal is sampled per second is called the sampling frequency, while the degree of fineness when converting the sound level into a numeric value is called the number of quantized bits.

The range of rates that can be played back is determined based on the sampling rate, while the dynamic range representing the sound level difference is determined by the number of quantized bits. In principle, the higher the sampling frequency, the wider the range of frequencies that can be played back, and the higher the number of quantized bits, the more finely the sound level can be reproduced.

■ S-video signal

With the S-video signal system, the video signal normally transmitted using a pin cable is separated and transmitted as the Y signal for the luminance and the C signal for the chrominance through the S-video cable. Using the S VIDEO jack eliminates video signal transmission loss and allows recording and playback of even more beautiful images.

■ Component video signal

With the component video signal system, the video signal is separated into the Y signal for the luminance and the Pb and Pr signals for the chrominance. Color can be reproduced more faithfully with this system because each of these signals is independent. The component signal is also called the “color difference signal” because the luminance signal is subtracted from the color signal. A monitor with component input jacks is required in order to use the component signal for output.

SPECIFICATIONS

AUDIO SECTION

- Minimum RMS Output Power for Main, Center, Rear, Rear Center
 - RX-V540** [U.S.A. and Canada models]
 - 20 Hz to 20 kHz, 0.06% THD, 8 Ω 80 W
 - 1 kHz, 0.7% THD, 8 Ω 95 W
 - RX-V540** [Other models]
 - 20 Hz to 20 kHz, 0.06% THD, 8 Ω 70 W
 - 1 kHz, 0.7% THD, 8 Ω 85 W
 - RX-V440** [U.S.A. and Canada models]
 - 20 Hz to 20 kHz, 0.06% THD, 8 Ω 75 W
 - 1 kHz, 0.7% THD, 8 Ω 90 W
 - RX-V440** [Other models]
 - 20 Hz to 20 kHz, 0.06% THD, 8 Ω 65 W
 - 1 kHz, 0.7% THD, 8 Ω 80 W
- DIN Standard Output Power [Europe model]
 - 1 kHz, 0.7% THD, 4 Ω **RX-V540** 115 W
 - RX-V440** 110 W
- Maximum Power (EIAJ) [China, Korea and General models]
 - 1 kHz, 10% THD, 8 Ω **RX-V540** 100 W
 - RX-V440** 95 W
- Dynamic Power (IHF) 8/6/4/2 Ω
 - RX-V540** [U.S.A. and Canada models] 100/125/160/200 W
 - [Other models] 90/110/145/180 W
 - RX-V440** [U.S.A. and Canada models] 95/120/150/190 W
 - [Other models] 85/105/140/170 W
- Damping Factor
 - 20 Hz to 20 kHz, 8 Ω 100 or more
- Frequency Response
 - CD to Main L/R 10 Hz to 100 kHz, -3 dB
- Total Harmonic Distortion
 - 20 Hz to 20 kHz, 40 W, 8 Ω, Main L/R 0.06%
- Signal to Noise Ratio (IHF-A Network)
 - CD (250 mV, shorted) to Main L/R, Effect Off 100 dB
- Residual Noise (IHF-A Network)
 - Main L/R 150 μV or less
- Channel Separation (1 kHz/10 kHz)
 - CD (5.1 kΩ terminated) to Main L/R 60 dB/45 dB
- Tone Control (Main L/R)
 - BASS Boost/Cut ±10 dB/60 Hz
 - TREBLE Boost/Cut ±10 dB/20 kHz
- Phones Output 150 mV/100 Ω
- Input Sensitivity
 - CD, etc 150 mV/47 kΩ
 - 6CH INPUT 150 mV/47 kΩ
- Output Level
 - OUT (REC) 150 mV/1.2 kΩ
 - OUTPUT SUBWOOFER 4 V/1.2 kΩ

VIDEO SECTION

- Video Signal Type NTSC or PAL
- Signal to Noise Ratio 50 dB
- Frequency Response (MONITOR OUT)
 - Composite, S-Video **RX-V540** 5 Hz to 10 MHz, -3 dB
 - Component DC to 30 MHz, -3 dB

FM SECTION

- Tuning Range
 - [U.S.A. and Canada models] 87.5 to 107.9 MHz
 - [Other models] 87.50 to 108.00 MHz
- 50 dB Quieting Sensitivity (IHF, 100% mod.)
 - Mono/Stereo 2.0 μV (17.3 dBf) /25 μV (39.2 dBf)
- Usable sensitivity (IHF, Mono) 1.0 μV (11.2 dBf)
- Signal to Noise Ratio (IHF)
 - Mono/Stereo 76 dB/70 dB
- Harmonic Distortion (1 kHz)
 - Mono/Stereo 0.2%/0.3%
- Stereo Separation (1 kHz) 42 dB
- Frequency Response 20 Hz to 15 kHz +0.5, -2 dB

AM SECTION

- Tuning Range 530/531 to 1710/1611 kHz
- Usable Sensitivity 300 μV/m

GENERAL

- Power Supply
 - [U.S.A. and Canada models] AC 120 V/60 Hz
 - [Australia model] AC 240 V/50 Hz
 - [U.K., Europe and Singapore models] AC 230 V/50 Hz
 - [Korea model] AC 220 V/60 Hz
 - [China and General models] AC 110/120/220/240 V, 50/60 Hz
- Power Consumption
 - [U.S.A. and Canada models] 270 W/360 VA
 - [Other models] 270 W
 - Standby Mode approx. 0.8 W
- AC Outlets
 - [U.S.A., Canada, Europe and Singapore models] 2 (Total 100 W maximum)
 - [China and General models] 2 (Total 50 W maximum)
 - [U.K. and Australia models] 1 (100 W maximum)
- Dimension (W x H x D)
 - 435 x 161 x 390 mm (17-1/8" x 6-3/8" x 15-3/8")
- Weight 11.0 kg (24 lbs 4 oz)

*Specifications are subject to change without notice.

LIST OF MANUFACTURER CODES

TV		DAYTRON	0941, 1031	JBL	0101	1111, 1321, 1711	
A TANDY	0941	DECCA	0271, 1001	JCB	0951	NECKERMANN	1001
ABEX	1151	DIXI	0331, 1001, 1071	JENSEN	0311	NEI	1001
ADMIRA	1141	DUMONT	0891, 1031	JINXING	1531, 1541, 1551,	NIKKAI	0271, 0431, 1001,
ADVENTURA	1131	DYNATECH	0881		1561, 1571, 1621,		1151
AIKO	1121	ELECTROBAND	0951, 1011		1631, 1641, 1651,	NIKKO	0861, 1111, 1121
AIWA	1481	ELECTROHOME	0941		1691, 1731	NOVABEAM	0721
AKAI	0331, 1101, 1111	ELECTRON	0941	JVC (VICTOR)	0261, 0281, 0641,	NTC	1121
ALBA	0431	ELIN	1001		0651, 0661, 0841	ONWA	1051
ALLERON	1091	ELTA	0331	KAWASHO	0901	OPTIMUS	0551
AMBASSADOR	1081	EMERSON	0001, 0021, 0061,	KAYPANI	1021	OPTONICA	0541, 1141
AMSTRAD	0481, 1081		0071, 0081, 0091,	KENWOOD	0361, 1031, 1111	ORION	0831, 1001
ANAM	0251, 1041, 1051,		0111, 0811, 0821,	KLOSS	0631, 0721, 1131	OSAKI	0271, 1151
	1061, 1071		0831, 0841, 0851,	KTV	0921, 0941, 1011,	OTTO VERSAND	1001
ANAM NATIONAL	1041		0861, 0871, 0901,		1051, 1111	PANASONIC	0101, 0191, 0251,
AOC	0361, 1021, 1031,		0921, 0941, 0981,	LEYCO	1001		0751, 1041, 1311,
	1111, 1161		1011, 1031, 1051,	LG (GOLDSTAR)	0031, 0121,		1371, 1431
ARCHER	1161	ENVISION	1081, 1091		0351, 0411, 0731,	PANDA	1541, 1721
AUDIOSONIC	1001		0361, 1111		0741, 0861, 0941,	PENNY	0161, 0361, 0521,
AUDIOVOX	1051, 1161	ERRES	1001		0971, 1001, 1031,		0531, 0621, 0731,
BAUER	0441	ETRON	0331	LIESENK & TTER	1111, 1151		0751, 0761, 0781,
BAUR	1001	FERGUSON	1001		1001		0791, 0861, 0931,
BEIJING	1511, 1551, 1561	FINLUX	1001	LLOYTRON	0941		0941, 1031, 1041,
BELCOR	1031	FISHER	0171, 0801, 0981	LOEWE	1001		1111, 1151, 1161
BELL & HOWELL	0981, 0991	FORMENTI	0441	LOGIK	0991, 1771	PEONY	1561, 1621
BEON	1001	FORMONTI	1001	LUXMAN	0351, 0971	PHILCO	0361, 0581, 0591,
BRADFORD	1051	FORTRESS	1141	LXI	0101, 0621, 0761,		0601, 0611, 0631,
BROCKWOOD	1031	FUJITSU	1091		0861, 0981		0961, 1031, 1111
BROKSONIC	1161	FUNAI	1051, 1091, 1501,	MAGNAVOX	0101, 0341, 0391,	PHILIPS	0101, 0401, 1001
BUSH	1001		1521		0401, 0411, 0421,	PHONOLA	1001
CANDLE	0351, 0361, 0961,	FUTURETECH	1051		0581, 0591, 0601,	PILOT	0941, 1031, 1111
	0971, 1111, 1131	GE	0131, 0161, 0201,		0611, 0631, 0661,	PIONEER	0511, 0551, 0871
CAPEHART	1021		0751, 0761, 0771,	MAJESTIC	0991	PORTLAND	0941, 1031, 1121
CARVER	0101		0781, 0791, 0811,	MARANTZ	0101, 0221, 0361,	PRICECLUB	0931
CATHAY	1001	GEC	0861, 1041		1001, 1111	PRISM	0751
CELEBRITY	0951		0271, 1001	MARK	1001	PROSCAN	0761
CENTURION	0411	GEMINI	0391	MARKSUI	0271, 0331, 1001	PROTECH	1001
CHANGHONG	1541, 1551, 1561,	GENEXXA	0431	MEDIATOR	1001	PROTON	0501, 0861, 0941,
	1621	GIBRALTER	0891, 1031, 1111	MEGATRON	0691, 0861, 1161		1021, 1161
CITIZEN	0351, 0361, 0921,	GOODMANS/TASHIKO	0271, 0661, 1001	MEI	1011	PULSAR	0891
	0931, 0941, 0961,	GRANADA	1001	M-ELECTRONIC	1001	PULSER	1031
	0971, 1111, 1121,	GRUNDIG	1781, 1791, 1801,	MEMOREX	0331, 0571, 0861,	QUASAR	0251, 0751, 1041
	1131		1811, 1821, 1831,		0971, 0981, 0991,	QUELLE	1001
CLAIRTONE	1011		1841, 1851, 1861,		1771	RADIO SHACK	0541, 0941,
CLARIVOX	1001		1871, 1881	METZ	1791, 1831, 1891,		1031, 1051,
CONCERTO	0351, 0971	GUNPY	1051, 1091		1901, 1911, 1921,	RADIOLA	1001
CONROWA	1751	HARMAN/KARDON	0721		1931, 1941	RCA	0051, 0141, 0151,
CONTEC	0901, 0911, 1011,	HALLMARK	0861	MGA	0361, 0561, 0571,		0181, 0411, 0491,
	1051	HANSEATIC	1001		0861, 1031, 1111		0531, 0761, 0771,
CORANDO	0941	HARVARD	1051, 1061	MIDLAND	0751, 0761, 0891,		0871, 1031
CRAIG	0251, 1051	HINARI	1001, 1091		0941, 1151	REALISTIC	0541, 0861, 0941,
CROWN	0941, 1051	HITACHI	0181, 0351, 0671,	MITSUBISHI	0221, 0321, 0561,		0971, 0981, 1031,
CURTIS MATHES	0161, 0361,		0681, 0691, 0701,		0571, 0661, 0861,		1051, 1111, 1151
	0931, 0941,		0711, 0871, 0941,		1031, 1101, 1381	RHAPSODY	1011
	0981, 1111		0971, 1351	MONTGOMERY	1091	R-LINE	1001
CXC	1051	HYPSON	1001	MOTOROLA	1041, 1141	RUNCO	0891, 1111
DAEWOO	0291, 0301, 0331,	IMA	1051	MTC	0351, 0361, 0881,	SAISHO	0331, 1081
	0721, 0941, 1001,	INDIANA	1001		0931, 0971, 1011,	SAMPO	0361, 0941, 1021,
	1031, 1121, 1191,	INFINITY REFERENCE	0101		1031, 1111		1111, 1151
	1531, 1581, 1591,		0101	MULTITECH	0881, 1051	SAMSUNG	0331, 0341, 0351,
	1601	INTERFUNK	1001	NAD	0551, 0621, 0861		0361, 0861, 0931,
DANSAI	1001	ITT	0611	NEC	0241, 0351, 0361,		0941, 0971, 1001,
		JANEIL	1131		0661, 0971, 1031,		1031, 1111, 1151

SAMSUX	0941	UNIVERSUM	1001
SANYO	0171, 0231, 0271, 0661, 0801, 0911, 0981, 1231, 1251, 1261	VECTOR RESEARCH	0361, 1111
SBR	1001	VESTEL	1001
SCHEIDER	1001	VIDEO CONCEPT	1101
SCIMITSU	1031	VIDIKRON	0101, 0211
SCOTCH	0861	VIDTECH	0861, 1031
SCOTT	0831, 0861, 0941, 1031, 1051, 1091	VIKING	1131
SEARS	0101, 0161, 0171, 0351, 0481, 0521, 0621, 0761, 0801, 0861, 0971, 0981, 1091	WARDS	0101, 0361, 0451, 0541, 0581, 0591, 0601, 0611, 0771, 0781, 0791, 0861, 0971, 0991, 1031, 1091, 1111, 1771
SHANGHAI	1561, 1681	WATSON	1001
SHARP	0461, 0471, 0541, 0661, 0911, 0941, 1141	XOGEGO	1611, 1621, 1661, 1741, 1761
SHOGUN	1031	YAMAHA	0361, 1031, 1111
SIGNATURE	0991, 1771	YOKO	1001
SIMPSON	0581, 0961	ZENITH	0011, 0041, 0891, 0991, 1771
SOLAVOX	1151	ZONDA	1161
SONOKO	1001		
SONTEC	1001		
SONY	0371, 0451, 0661, 0841, 0951, 1281, 1441		
SOUNDESIGN	0861, 0961, 1051, 1091		
SOUNDWAVE	1001		
SPECTRICON	1161		
SQUAREVIEW	0481		
SSS	1031, 1051		
STAR-LITE	1051		
SUPREM	0951		
SUPRE-MACY	1131		
SURPA	0351, 0971		
SYLVANIA	0101, 0361, 0441, 0581, 0591, 0601, 0611, 0631, 0961, 1111		
SYMPHONIC	0481		
SYSLINE	1001		
TANDY	0271, 0431, 1141		
TATUNG	0271, 0881, 1001, 1041, 1161		
TCL	1561, 1631, 1701		
TECHNICS	0751		
TECHWOOD	0351, 0751, 0971		
TEKNIKA	0101, 0351, 0571, 0931, 0941, 0961, 0971, 0991, 1031, 1051, 1091, 1121, 1131, 1771		
TELETECH	0331		
TERA	0501		
THAKRAL	1671		
THORM	1001		
TMK	0351, 0861, 0971, 1081		
TOSHIBA	0381, 0521, 0621, 0661, 0931, 0981, 1301		
TOSONIC	1011		
TOTEVISION	0941		
TRICAL	0911		
UNIVERSAL	0781, 0791		

CABLE TV

ABC	0256, 0376
ANTRONIX	0136
ARCHER	0136, 0286
BBT	0076
CABLETIME	0166
CABLEVISION	0196
COLOUR VOICE	0306, 0346
COMTRONICS	0216, 0276
EAGLE COMTRONICS	0276
EASTERN	0066
ELECTRICORD	0206
ELECTUS	0266
GE	0116, 0126
GEC CABLE SYSTEM	0196
HAMLIN H5	0676
HAMLIN H6	0666
HAMLIN H6S	0656
HAMLIN H8	0646
HAMLIN H9	0636
JERROLD	0256
JERROLD 400L	0626
JERROLD 450L	0616
JERROLD 550	0606
JERROLD OSD CATV	0596
JERROLD SPRUCER	0436
MAGNAVOX/PHILIPS	0416, 0426
MAMM	0296
MEMOREX	0386
MOVIE TIME	0146, 0206
NORTHCOAST	0016
NSC	0146
OAK	0106
OAK SIGMA 450	0546
OAK SIGMA 550	0536
PANASONIC TZ 120/130	0476
PANASONIC TZ 170/180	0446
PANASONIC TZ140	0466

PANASONIC TZ150/160	0456
PARAGON	0386
PHILIPS	0036, 0216, 0306, 0316, 0326, 0336, 0346
PIONEER	0006, 0086
PIONEER BR50	0846
PIONEER BR60/70/80/81/82	0696
PIONEER BR90	0556
PULSAR	0386
RCA DIGITAL SATELLITE	
SYSTEM	0396, 0406
REALISTIC	0136
REGENCY/EASTERN	0686
RUNCO	0386
SAMSUNG	0276
SCIENTIFIC ATLANTA 175/475	0576
SCIENTIFIC ATLANTA 75	0366, 0586
SCIENTIFIC ATLANTA 8650	0566
SIGNAL	0276
SL MARX	0276
SPECTAVISION	0236
STANDARD COMPONENTS	0186
STARCOM V	0256
STARGATE	0276
SYLVANIA/TEXSCAN	0376, 0496
TEKNIKA	0176
TELESERVICE	0056
TELEVIEW	0276
TEXSCAN	0186, 0376
TFC	0026
TOCOM	0226, 0356
TOCOM 5503A	0526
TOCOM 5503VIP/5507	0516
TOCOM TC56	0506
TOSHIBA	0386
TUDI	0046
UNIKA	0136
UNIVERSAL	0136, 0156, 0206, 0286
VIDEOWAY	0096
VIEWSTAR	0216
ZENITH	0246, 0386, 0486

SATELLITE TUNER

ALPHA STAR	0826
CHAPARRAL	0756
ECHOSTAR	0836
GENERAL INSTRUMENT	0776, 0876
HTS	0836
HUGHES NETWORK SYSTEMS	0816
JERROLD	0776, 0786
PANASONIC	0806
PRIMESTAR	0776, 0786
RCA	0766
SONY	0796

(DBS)

HITACHI	0856
MAGNAVOX	0886
MEMOREX	0886
PANASONIC	0896
PHILIPS	0886
SONY	0906
STAR CHOICE	0876
TOSHIBA	0866, 0916
UNIDEN	0886

VCR

A TANDY	0902
ADVENTURA	0992
AIKO	0982
AIWA	0992
AKAI	0262, 0942, 0952, 0962, 0972
AMERICAN HIGH	0932
AMSTRAD	0992
ASA	0002, 0912
ASHA	0922
AUDIO DYNAMICS	0202
AUDIOVOX	0912
BEAUMARK	0922
BELL & HOWELL	0902
BLAUPUNKT	0412
BROKSONIC	0872, 0882, 0892
BUSH	0852
CALIX	0912
CANON	0862, 0932
CCE	0852, 0982
CITIZEN	0912, 0982
COLT	0852
CRAIG	0832, 0842, 0852, 0912, 0922
CURTIS MATHES	0662, 0822, 0932
CYBERNEX	0922
DAEWOO	0802, 0812, 0982
DBX	0202
DYNATECH	0472, 0992
ELECTROHOME	0912
ELECTROPHONIC	0912
EMEREX	0792
EMERSON	0072, 0132, 0142, 0152, 0162, 0172, 0182, 0192, 0212, 0702, 0712, 0722, 0732, 0742, 0752, 0762, 0772, 0782, 0872, 0882, 0892, 0912, 0952, 0992, 1072
FINLUX	0002, 0992
FISHER	0682, 0692, 0842, 0902
FUJI	0672, 0932
FUNAI	0992
GARRARD	0992
GE	0662, 0822, 0932
GO VIDEO	0642, 0652
GOODMANS	0402
GRADIENTE	0992
GRANDA	0612, 0902
GRUNDIG	0002
HARLEY DAVIDSON	0992

HARMAN/KARDON		PROSCAN	1002, 1012, 1022, 1032, 1042, 1052, 1062	YAMAHA	0202, 0632	CARVER	0285, 1135		
0632, 1082				ZENITH	0042, 0362, 0512, 0672	CASIO	0345		
HARWOOD	0752, 0852	PULSAR	0512	<hr/>				CROWN	0185
HEADQUARTER	0612	QUARTER	0612	DVD PLAYER				CURTIS MATHES	0345
HI-Q	0842	QUARTZ	0272, 0612	AKAI	0058	DENON	0275, 0875, 0885		
HINARI	0852	QUASAR	0382, 0392, 0932	AIWA	0218	DEUAL (E)	0505		
HITACHI	0102, 0562, 0572, 0582, 0592, 0602, 0992	RADIO SHACK	0912, 0992	DENON	0188	DYNAMIC BASS (H)	0555		
ITT	0942	RADIX	0912	HITACHI	0198	EMERSON	0205, 0325, 1105		
JVC (VICTOR)	0202, 0522, 0532, 0542, 0552	RANDEX	0912	JVC (VICTOR)	0088, 0178	EROICA	1275		
KENWOOD	0202, 0542, 0612, 0632, 0902	RCA	0112, 0382, 0392, 0482, 0592, 0602, 0662, 0822, 0942	KENWOOD	0148	FISHER	0095, 0555, 0925, 1005		
KLH	0852	REALISTIC	0402, 0472, 0612, 0682, 0842, 0902, 0912, 0922, 0932, 0992	LG (GOLDSTAR)	0228	GARRARD	0365		
KODAK	0912, 0932	RICOH	0352, 0362	MAGNAVOX	0128	GENEXXA	0305, 0325, 1105		
LG (GOLDSTAR)	0082, 0632, 0912	SAISHO	0212, 0582, 0722, 0732, 0742, 0772	MINI-MITSUBISHI	0138	HARMAN/KARDON	0105, 0175, 0465, 0995		
LLOYD	0992	SALORA	0612, 0762	ONKYO	0068, 0128	HITACHI	0195, 0205, 0505, 0815		
LOGIK	0852	SAMSUNG	0212, 0312, 0922, 0962	PANASONIC	0028	INDEL	0115, 0395		
LUXOR	0942	SANKY	0472, 0512	PHILIPS	0098, 0128	JVC (VICTOR)	0315		
LXI	0022, 0912	SANSUI	0292, 0542, 0832	PIONEER	0108, 0118	KENWOOD	0045, 0095, 0405, 0585, 0725, 0735, 0745, 0755, 0895		
MAGNAVOX	0002, 0482, 0492, 0502, 0512, 0932	SANYO	0242, 0612, 0842, 0902, 0922	RCA	0158	KYOCERA	0025		
MAGNIN	0922	SBR	0002, 0282	SAMSUNG	0078	LG (GOLDSTAR)	1135, 1225, 1265, 1335		
MARANTZ	0002, 0202, 0402, 0632, 0932	SCHEIDER	0852	SHARP	0038	LUXMAN	0075, 0425, 0675, 0705, 0715, 0985		
MARTA	0912	SCOTT	0342, 0712, 0762, 0872, 0882, 0892	SONY	0018	MAGNAVOX	0165, 0215, 0645, 0955		
MATSUSHITA	0932	SEARS	0302, 0592, 0602, 0612, 0682, 0692, 0842, 0902, 0912, 0932	TECHNICS	0028	MARANTZ	0215, 0235, 0375, 0785, 1345		
MATSUI	0722	SHARP	0402, 0472	THOMSON	0168	MCINTOSH	0355, 1085		
MEI	0222, 0932	SHINTOM	0852	TOSHIBA	0048, 0128	MCS	0905, 1315		
MEMOREX	0232, 0242, 0472, 0512, 0612, 0842, 0902, 0912, 0922, 0932, 0992	SHOGUN	0922	YAMAHA	0008, 0028, 0098, 0208	MEMOREX	0205, 0225, 0235, 0305, 0325, 1105		
MGA	0762, 0952	SINGER	0852	ZENITH	0128	MGA	0135		
MGA TECHNOLOGY	0922	SONY	0032, 0332, 0352, 0362, 0672, 0792, 0932	<hr/>				MISSION	0215
MINOLTA	0592, 0602	STS	0602	LD PLAYER				MITSUBISHI	0135, 0445
MINI-MITSUBISHI	0452, 0462, 0542, 0762, 0952, 1082	SUNPAK	0352	AIWA	0157	MTC	1255		
MOTOROLA	0472, 0932	SYLVANIA	0002, 0492, 0502, 0762, 0932, 0992	DENON	0147	NAD	0035, 0615, 0685, 0695		
MTC	0922, 0992	SYMPHONIC	0992	DISCO VISION	0017	NAKAMICHI	0125, 0435, 0515		
MULTITECH	0852, 0992	TANDY	0992	FUNAI	0157	NEC	0255, 0905, 0965		
NAD	0442	TASHIKO	0712, 0992	HITACHI (E)	0017	NIKKO	0545, 1005		
NEC	0122, 0202, 0292, 0422, 0432, 0542, 0632	TEAC	0992	KENWOOD	0087, 0107	ONKYO	0155, 0455, 0495, 0805, 1155		
NIKKO	0912	TECHNICS	0932	MAGNAVOX	0027	OPTIMUS	0225, 0245, 0555, 0595, 0845, 0855, 0865, 0895, 0935		
NOBLEX	0922	TEKNIKA	0322, 0912, 0932, 0992	MARANTZ	0027	PANASONIC	0055, 0825, 1095, 1125		
OLYMPUS	0412, 0932	TELEFUNKEN	0252	MITSUBISHI	0137	PENNY	0905		
OPTIMUS	0442, 0472, 0912	TMK	0212, 0732, 0772, 0922	NAD	0137	PHILIPS	0165, 0215		
OPTONICA	0402	TOSHIBA	0062, 0302, 0342, 0622, 0682, 0712, 0762	PANASONIC	0077, 0177	PIONEER	0305, 0935, 1045		
ORION	0212, 0722, 0742, 0772	TOTEVISION	0912, 0922	PHILIPS	0027	PROTON	0215, 1185		
OSAKI	0912	UNITECH	0922	PIONEER	0017, 0037, 0137	QUASAR	0055		
PANASONIC	0012, 0052, 0092, 0222, 0372, 0382, 0392, 0412, 0932	VECTOR RESEARCH	0202, 0432, 0632	RCA	0167	RCA	0205, 0915, 1115		
PENNY	0202, 0432, 0602, 0632, 0692, 0912, 0922, 0932	VIDEO CONCEPTS	0202, 0432, 0632, 0952	REALISTIC	0157	REALISTIC	0205, 0225, 0235, 0325, 0555, 0845		
PENTAX	0592, 0602	WARDS	0322, 0402, 0472, 0482, 0602, 0712, 0842, 0852, 0922, 0932, 0992	SHARP	0127	REVOX	1175		
PERDIO	0992			SONY	0047, 0057, 0117	ROTEL	0215		
PHILCO	0002, 0932			VICTOR	0097	SABA TELECOMMANDER (E)	0505		
PHILIPS	0002, 0282, 0402, 0492, 0932			YAMAHA	0007, 0067	SAE	0215		
PILOT	0912			<hr/>				SAMSUNG	1285
PIONEER	0442, 0542			CD PLAYER				SANSUI	0215, 0625, 0975, 1025, 1105

SANYO	0145, 0555, 0635, 0765	OPTIMUS	0034, 0064, 0204, 0334
SCOTT	0325, 1105	ONKYO	0364, 0374
SEARS	0345	PHILIPS	0094
SHARP	0235, 0665, 0895, 1065, 1075	PIONEER	0034, 0044, 0064
SHERWOOD	0115, 0235, 0395, 0475	REVOX	0354
SIEMENS GARRARD		SANSUI	0094, 0344
	1245	SHARP	0264
SIGNATURE	0175	SHERWOOD	0334
SONTEC	1165	SONY	0054, 0084, 0324
SONY	0065, 0565, 0865, 1145	TEAC	0194, 0254
STARON	1235	TECHNICS	0074, 0314
STS	0025	WARDS	0034
SYLVANIA	0215	YAMAHA	0004, 0014, 0104, 0114, 0164, 0174, 0264
SYMPHONIC	0335		
TANDY	0305		
TANGBERG	1195		
TEAC	0235, 0335, 0385, 0525, 0795, 0835, 1355		
TECHNICS	0055, 0605, 1095		
TECHWOOD	1325		
TELEFUNKEN (E)	0505		
THOMSON (E)	0505		
TOSHIBA	0035, 0685		
VECTOR RESEARCH			
	0065, 1135		
WARDS	0175		
YAMAHA	0005, 0015, 0085, 0415, 0545, 0575, 1065		

CD RECORDER/CD-RW

HITACHI	0474
JVC (VICTOR)	0504
MARANTZ	0484, 0494
PHILIPS	0444
PIONEER	0454
YAMAHA	0414

MD RECORDER

KENWOOD	0384
PIONEER	0424
SHARP	0434
SONY	0394
YAMAHA	0024, 0394, 0404, 0514

TAPE DECK

AIWA	0094, 0214, 0224
AKAI	0184
CARVER	0094
DENON	0304
FISHER	0144
GARRARD	0194, 0204
JVC (VICTOR)	0274, 0284, 0294
KENWOOD	0124, 0134, 0154, 0234, 0244, 0264
MAGNAVOX	0094
MARANTZ	0094, 0344
MITSUBISHI	0184



YAMAHA ELECTRONICS CORPORATION, USA 6660 ORANGETHORPE AVE., BUENA PARK, CALIF. 90620, U.S.A.
YAMAHA CANADA MUSIC LTD. 135 MILNER AVE., SCARBOROUGH, ONTARIO M1S 3R1, CANADA
YAMAHA ELECTRONIK EUROPA G.m.b.H. SIEMENSSTR. 22-34, 25462 RELLINGEN BEI HAMBURG, F.R. OF GERMANY
YAMAHA ELECTRONIQUE FRANCE S.A. RUE AMBROISE CROIZAT BP70 CROISSY-BEAUBOURG 77312 MARNE-LA-VALLEE CEDEX02, FRANCE
YAMAHA ELECTRONICS (UK) LTD. YAMAHA HOUSE, 200 RICKMANSWORTH ROAD WATFORD, HERTS WD1 7JS, ENGLAND
YAMAHA SCANDINAVIA A.B. J A WETTERGRENS GATA 1, BOX 30053, 400 43 VÄSTRA FRÖLUNDA, SWEDEN
YAMAHA MUSIC AUSTRALIA PTY, LTD. 17-33 MARKET ST., SOUTH MELBOURNE, 3205 VIC., AUSTRALIA

YAMAHA CORPORATION
Printed in Malaysia **UP** WA72720